

NCP302, NCP303

Voltage Detector Series with Programmable Delay

The NCP302 and NCP303 series are second generation ultra-low current voltage detectors that contain a programmable time delay generator. These devices are specifically designed for use as reset controllers in portable microprocessor based systems where extended battery life is paramount.

Each series features a highly accurate under voltage detector with hysteresis and an externally programmable time delay generator. This combination of features prevents erratic system reset operation.

The NCP302 series consists of complementary output devices that are available with either an active high or active low reset. The NCP303 series has an open drain N-channel output with an active low reset output.

The NCP302 and NCP303 device series are available in the TSOP-5 package with seven standard under voltage thresholds. Additional thresholds that range from 0.9 V to 4.9 V in 100 mV steps can be manufactured.

Features

- Quiescent Current of 0.5 μ A Typical
- High Accuracy Under Voltage Threshold of 2.0%
- Externally Programmable Time Delay Generator
- Wide Operating Voltage Range of 0.8 V to 10 V
- Complementary or Open Drain Output
- Active Low or Active High Reset

Typical Applications

- Microprocessor Reset Controller
- Low Battery Detection
- Power Fail Indicator
- Battery Backup Detection



ON Semiconductor

<http://onsemi.com>

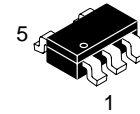

TSOP-5
SN SUFFIX
CASE 483

PIN CONNECTIONS AND MARKING DIAGRAM

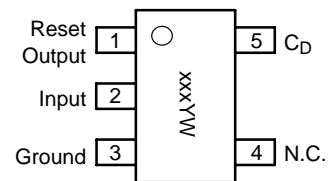

xxx = 302 or 303
Y = Year
W = Work Week
(Top View)

ORDERING INFORMATION

See detailed ordering and shipping information in the ordering information section on page 2 of this data sheet.

Representative Block Diagrams

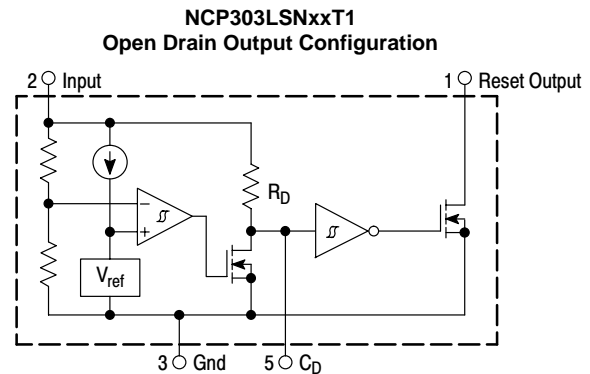
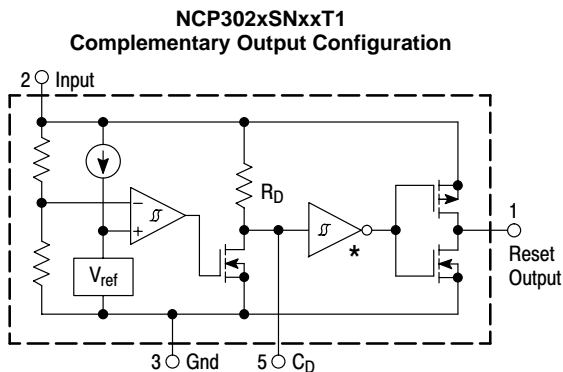

* Inverter for active low devices.
Buffer for active high devices.

This device contains 28 active transistors.

NCP302, NCP303

ORDERING INFORMATION

Device	Threshold Voltage	Output Type	Reset	Marking	Package (Qty/Reel)
NCP302LSN09T1	0.9	CMOS	Active Low	SBOYW	3000 Units on 7 inch Reel
NCP302LSN18T1	1.8			SBFYW	
NCP302LSN20T1	2.0			SBDYW	
NCP302LSN27T1	2.7			SAWYW	
NCP302LSN30T1	3.0			SATYW	
NCP302LSN45T1	4.5			SALYW	
NCP302LSN47T1	4.7			SACYW	
NCP302HSN09T1	0.9		Active High	SDOYW	
NCP302HSN18T1	1.8			SFHYW	
NCP302HSN20T1	2.0			SFGYW	
NCP302HSN27T1	2.7			SDKYW	
NCP302HSN30T1	3.0			SDIYW	
NCP302HSN45T1	4.5			SDGYW	
NCP302HSN47T1	4.7			SDFYW	
NCP303LSN09T1	0.9	Open Drain	Active Low	SDEYW	
NCP303LSN18T1	1.8			SCVYW	
NCP303LSN20T1	2.0			SCTYW	
NCP303LSN27T1	2.7			SCMYW	
NCP303LSN30T1	3.0			SCJYW	
NCP303LSN45T1	4.5			SBTYW	
NCP303LSN47T1	4.7			SBRYW	

NOTE: The ordering information lists seven standard under voltage thresholds with active low outputs. Additional active low threshold devices, ranging from 0.9 V to 4.9 V in 100 mV increments and NCP302 active high output devices, ranging from 0.9 V to 4.9 V in 100 μ V increments can be manufactured. Contact your ON Semiconductor representative for availability. The electrical characteristics of these additional devices are shown in Tables 1 and 2.

MAXIMUM RATINGS

Rating	Symbol	Value	Unit
Input Power Supply Voltage (Pin 2)	V_{in}	12	V
Output Voltage (Pin 1) Complementary, NCP302 N-Channel Open Drain, NCP303	V_{OUT}	-0.3 to $V_{in}+0.3$ -0.3 to 12	V
Output Current (Pin 1, Note 2)	I_{OUT}	70	mA
Thermal Resistance Junction to Air	$R_{\theta JA}$	250	$^{\circ}C/W$
Operating Junction Temperature Range	T_J	-40 to +125	$^{\circ}C$
Storage Temperature Range	T_{stg}	-55 to +150	$^{\circ}C$

NOTES:

- This device series contains ESD protection and exceeds the following tests:
Human Body Model 2000 V per MIL-STD-883, Method 3015.
Machine Model Method 200 V.
- The maximum package power dissipation limit must not be exceeded.

$$P_D = \frac{T_{J(max)} - T_A}{R_{\theta JA}}$$

NCP302, NCP303

ELECTRICAL CHARACTERISTICS (For all values $T_A = 25^\circ\text{C}$, unless otherwise noted.)

Characteristic	Symbol	Min	Typ	Max	Unit
NCP302/3 – 0.9					
Detector Threshold (Pin 2, V_{in} Decreasing)	V_{DET-}	0.882	0.900	0.918	V
Detector Threshold Hysteresis (Pin 2, V_{in} Increasing)	V_{HYS}	0.027	0.045	0.063	V
Supply Current (Pin 2) ($V_{in} = 0.8\text{ V}$) ($V_{in} = 2.9\text{ V}$)	I_{in}	– –	0.20 0.45	0.6 1.2	μA
Maximum Operating Voltage (Pin 2)	$V_{in(max)}$	–	–	10	V
Minimum Operating Voltage (Pin 2) ($T_A = -40^\circ\text{C}$ to 85°C)	$V_{in(min)}$	– –	0.55 0.65	0.70 0.80	V
Reset Output Current (Pin 1, Active Low 'L' Suffix Devices) Nch Sink Current, NCP302, NCP303 ($V_{OUT} = 0.05\text{V}$, $V_{in} = 0.70\text{V}$) ($V_{OUT} = 0.50\text{V}$, $V_{in} = 0.85\text{V}$) Pch Source Current, NCP302 ($V_{OUT} = 2.4\text{V}$, $V_{in} = 4.5\text{V}$)	I_{OUT}	0.01 0.05 1.0	0.05 0.50 2.0	– – –	mA
Delay Capacitor Pin Threshold Voltage (Pin 5)	V_{TCD}	0.50	0.67	0.84	V
Delay Capacitor Pin Sink Current (Pin 5) ($V_{in} = 0.7\text{ V}$, $V_{CD} = 0.1\text{V}$) ($V_{in} = 1.5\text{ V}$, $V_{CD} = 0.5\text{V}$)	I_{CD}	2.0 10	120 300	– –	μA
Delay Pullup Resistance (Pin 5)	R_D	0.5	1.0	2.0	$\text{M}\Omega$

ELECTRICAL CHARACTERISTICS (For all values $T_A = 25^\circ\text{C}$, unless otherwise noted.)

Characteristic	Symbol	Min	Typ	Max	Unit
NCP302/3 – 1.8					
Detector Threshold (Pin 2, V_{in} Decreasing)	V_{DET-}	1.764	1.80	1.836	V
Detector Threshold Hysteresis (Pin 2, V_{in} Increasing)	V_{HYS}	0.054	0.090	0.126	V
Supply Current (Pin 2) ($V_{in} = 1.7\text{ V}$) ($V_{in} = 3.8\text{ V}$)	I_{in}	– –	0.23 0.48	0.7 1.3	μA
Maximum Operating Voltage (Pin 2)	$V_{in(max)}$	–	–	10	V
Minimum Operating Voltage (Pin 2) ($T_A = -40^\circ\text{C}$ to 85°C)	$V_{in(min)}$	– –	0.55 0.65	0.70 0.80	V
Reset Output Current (Pin 1, Active Low 'L' Suffix Devices) Nch Sink Current, NCP302, NCP303 ($V_{OUT} = 0.05\text{V}$, $V_{in} = 0.70\text{V}$) ($V_{OUT} = 0.50\text{V}$, $V_{in} = 1.5\text{V}$) Pch Source Current, NCP302 ($V_{OUT} = 2.4\text{V}$, $V_{in} = 4.5\text{V}$)	I_{OUT}	0.01 1.0 1.0	0.05 2.0 2.0	– – –	mA
Delay Capacitor Pin Threshold Voltage (Pin 5)	V_{TCD}	0.99	1.34	1.68	V
Delay Capacitor Pin Sink Current (Pin 5) ($V_{in} = 0.7\text{ V}$, $V_{CD} = 0.1\text{V}$) ($V_{in} = 1.5\text{ V}$, $V_{CD} = 0.5\text{V}$)	I_{CD}	2.0 200	120 1600	– –	μA
Delay Pullup Resistance (Pin 5)	R_D	0.5	1.0	2.0	$\text{M}\Omega$

NCP302, NCP303

ELECTRICAL CHARACTERISTICS (For all values $T_A = 25^\circ\text{C}$, unless otherwise noted.)

Characteristic	Symbol	Min	Typ	Max	Unit
NCP302/3 – 2.0					
Detector Threshold (Pin 2, V_{in} Decreasing)	V_{DET-}	1.960	2.00	2.040	V
Detector Threshold Hysteresis (Pin 2, V_{in} Increasing)	V_{HYS}	0.06	0.10	0.14	V
Supply Current (Pin 2) ($V_{in} = 1.9\text{ V}$) ($V_{in} = 4.0\text{ V}$)	I_{in}	– –	0.23 0.48	0.8 1.3	μA
Maximum Operating Voltage (Pin 2)	$V_{in(max)}$	–	–	10	V
Minimum Operating Voltage (Pin 2) ($T_A = -40^\circ\text{C}$ to 85°C)	$V_{in(min)}$	– –	0.55 0.65	0.70 0.80	V
Reset Output Current (Pin 1, Active Low 'L' Suffix Devices) Nch Sink Current, NCP302, NCP303 ($V_{OUT} = 0.05\text{V}$, $V_{in} = 0.70\text{V}$) ($V_{OUT} = 0.50\text{V}$, $V_{in} = 1.5\text{V}$) Pch Source Current, NCP302 ($V_{OUT} = 2.4\text{V}$, $V_{in} = 4.5\text{V}$)	I_{OUT}	0.01 1.0 1.0	0.05 2.0 2.0	– – –	mA
Delay Capacitor Pin Threshold Voltage (Pin 5)	V_{TCD}	1.10	1.49	1.87	V
Delay Capacitor Pin Sink Current (Pin 5) ($V_{in} = 0.7\text{ V}$, $V_{CD} = 0.1\text{V}$) ($V_{in} = 1.5\text{ V}$, $V_{CD} = 0.5\text{V}$)	I_{CD}	2.0 200	120 1600	– –	μA
Delay Pullup Resistance (Pin 5)	R_D	0.5	1.0	2.0	$\text{M}\Omega$

ELECTRICAL CHARACTERISTICS (For all values $T_A = 25^\circ\text{C}$, unless otherwise noted.)

Characteristic	Symbol	Min	Typ	Max	Unit
NCP302/3– 2.7					
Detector Threshold (Pin 2, V_{in} Decreasing)	V_{DET-}	2.646	2.700	2.754	V
Detector Threshold Hysteresis (Pin 2, V_{in} Increasing)	V_{HYS}	0.081	0.135	0.189	V
Supply Current (Pin 2) ($V_{in} = 2.6\text{ V}$) ($V_{in} = 4.7\text{ V}$)	I_{in}	– –	0.26 0.46	0.8 1.3	μA
Maximum Operating Voltage (Pin 2)	$V_{in(max)}$	–	–	10	V
Minimum Operating Voltage (Pin 2) ($T_A = -40^\circ\text{C}$ to 85°C)	$V_{in(min)}$	– –	0.55 0.65	0.70 0.80	V
Reset Output Current (Pin 1, Active Low 'L' Suffix Devices) Nch Sink Current, NCP302, NCP303 ($V_{OUT} = 0.05\text{V}$, $V_{in} = 0.70\text{V}$) ($V_{OUT} = 0.50\text{V}$, $V_{in} = 1.5\text{V}$) Pch Source Current, NCP302 ($V_{OUT} = 2.4\text{V}$, $V_{in} = 4.5\text{V}$)	I_{OUT}	0.01 1.0 1.0	0.05 2.0 2.0	– – –	mA
Delay Capacitor Pin Threshold Voltage (Pin 5)	V_{TCD}	1.49	2.01	2.53	V
Delay Capacitor Pin Sink Current (Pin 5) ($V_{in} = 0.7\text{ V}$, $V_{CD} = 0.1\text{V}$) ($V_{in} = 1.5\text{ V}$, $V_{CD} = 0.5\text{V}$)	I_{CD}	2.0 200	120 1600	– –	μA
Delay Pullup Resistance (Pin 5)	R_D	0.5	1.0	2.0	$\text{M}\Omega$

NCP302, NCP303

ELECTRICAL CHARACTERISTICS (For all values $T_A = 25^\circ\text{C}$, unless otherwise noted.)

Characteristic	Symbol	Min	Typ	Max	Unit
NCP302/3 – 3.0					
Detector Threshold (Pin 2, V_{in} Decreasing)	V_{DET-}	2.94	3.00	3.06	V
Detector Threshold Hysteresis (Pin 2, V_{in} Increasing)	V_{HYS}	0.09	0.15	0.21	V
Supply Current (Pin 2) ($V_{in} = 2.87\text{ V}$) ($V_{in} = 5.0\text{ V}$)	I_{in}	– –	0.27 0.47	0.9 1.3	μA
Maximum Operating Voltage (Pin 2)	$V_{in(max)}$	–	–	10	V
Minimum Operating Voltage (Pin 2) ($T_A = -40^\circ\text{C}$ to 85°C)	$V_{in(min)}$	– –	0.55 0.65	0.70 0.80	V
Reset Output Current (Pin 1, Active Low 'L' Suffix Devices) Nch Sink Current, NCP302, NCP303 ($V_{OUT} = 0.05\text{V}$, $V_{in} = 0.70\text{V}$) ($V_{OUT} = 0.50\text{V}$, $V_{in} = 1.5\text{V}$) Pch Source Current, NCP302 ($V_{OUT} = 2.4\text{V}$, $V_{in} = 4.5\text{V}$)	I_{OUT}	0.01 1.0 1.0	0.05 2.0 2.0	– – –	mA
Delay Capacitor Pin Threshold Voltage (Pin 5)	V_{TCD}	1.65	2.23	2.81	V
Delay Capacitor Pin Sink Current (Pin 5) ($V_{in} = 0.7\text{ V}$, $V_{CD} = 0.1\text{V}$) ($V_{in} = 1.5\text{ V}$, $V_{CD} = 0.5\text{V}$)	I_{CD}	2.0 200	120 1600	– –	μA
Delay Pullup Resistance (Pin 5)	R_D	0.5	1.0	2.0	$\text{M}\Omega$

ELECTRICAL CHARACTERISTICS (For all values $T_A = 25^\circ\text{C}$, unless otherwise noted.)

Characteristic	Symbol	Min	Typ	Max	Unit
NCP302/3 – 4.5					
Detector Threshold (Pin 2, V_{in} Decreasing)	V_{DET-}	4.410	4.500	4.590	V
Detector Threshold Hysteresis (Pin 2, V_{in} Increasing)	V_{HYS}	0.135	0.225	0.315	V
Supply Current (Pin 2) ($V_{in} = 4.34\text{ V}$) ($V_{in} = 6.5\text{ V}$)	I_{in}	– –	0.33 0.52	1.0 1.4	μA
Maximum Operating Voltage (Pin 2)	$V_{in(max)}$	–	–	10	V
Minimum Operating Voltage (Pin 2) ($T_A = -40^\circ\text{C}$ to 85°C)	$V_{in(min)}$	– –	0.55 0.65	0.70 0.80	V
Reset Output Current (Pin 1, Active Low 'L' Suffix Devices) Nch Sink Current, NCP302, NCP303 ($V_{OUT} = 0.05\text{V}$, $V_{in} = 0.70\text{V}$) ($V_{OUT} = 0.50\text{V}$, $V_{in} = 1.5\text{V}$) Pch Source Current, NCP302 ($V_{OUT} = 5.9\text{V}$, $V_{in} = 8.0\text{V}$)	I_{OUT}	0.01 1.0 1.5	0.05 2.0 3.0	– – –	mA
Delay Capacitor Pin Threshold Voltage (Pin 5)	V_{TCD}	2.25	3.04	3.83	V
Delay Capacitor Pin Sink Current (Pin 5) ($V_{in} = 0.7\text{ V}$, $V_{CD} = 0.1\text{V}$) ($V_{in} = 1.5\text{ V}$, $V_{CD} = 0.5\text{V}$)	I_{CD}	2.0 200	120 1600	– –	μA
Delay Pullup Resistance (Pin 5)	R_D	0.5	1.0	2.0	$\text{M}\Omega$

NCP302, NCP303

ELECTRICAL CHARACTERISTICS (For all values $T_A = 25^\circ\text{C}$, unless otherwise noted.)

Characteristic	Symbol	Min	Typ	Max	Unit
NCP302/3 – 4.7					
Detector Threshold (Pin 2, V_{in} Decreasing)	V_{DET-}	4.606	4.70	4.794	V
Detector Threshold Hysteresis (Pin 2, V_{in} Increasing)	V_{HYS}	0.141	0.235	0.329	V
Supply Current (Pin 2) ($V_{in} = 4.54\text{ V}$) ($V_{in} = 6.7\text{ V}$)	I_{in}	–	0.34 0.53	1.0 1.4	μA
Maximum Operating Voltage (Pin 2)	$V_{in(max)}$	–	–	10	V
Minimum Operating Voltage (Pin 2) ($T_A = -40^\circ\text{C}$ to 85°C)	$V_{in(min)}$	–	0.55 0.65	0.70 0.80	V
Reset Output Current (Pin 1, Active Low 'L' Suffix Devices) Nch Sink Current, NCP302, NCP303 ($V_{OUT} = 0.05\text{V}$, $V_{in} = 0.70\text{V}$) ($V_{OUT} = 0.50\text{V}$, $V_{in} = 1.5\text{V}$) Pch Source Current, NCP302 ($V_{OUT} = 5.9\text{V}$, $V_{in} = 8.0\text{V}$)	I_{OUT}	0.01 1.0 1.5	0.05 2.0 3.0	– – –	mA
Delay Capacitor Pin Threshold Voltage (Pin 5)	V_{TCD}	2.59	3.49	4.40	V
Delay Capacitor Pin Sink Current (Pin 5) ($V_{in} = 0.7\text{ V}$, $V_{CD} = 0.1\text{V}$) ($V_{in} = 1.5\text{ V}$, $V_{CD} = 0.5\text{V}$)	I_{CD}	2.0 200	120 1600	– –	μA
Delay Pullup Resistance (Pin 5)	R_D	0.5	1.0	2.0	$\text{M}\Omega$

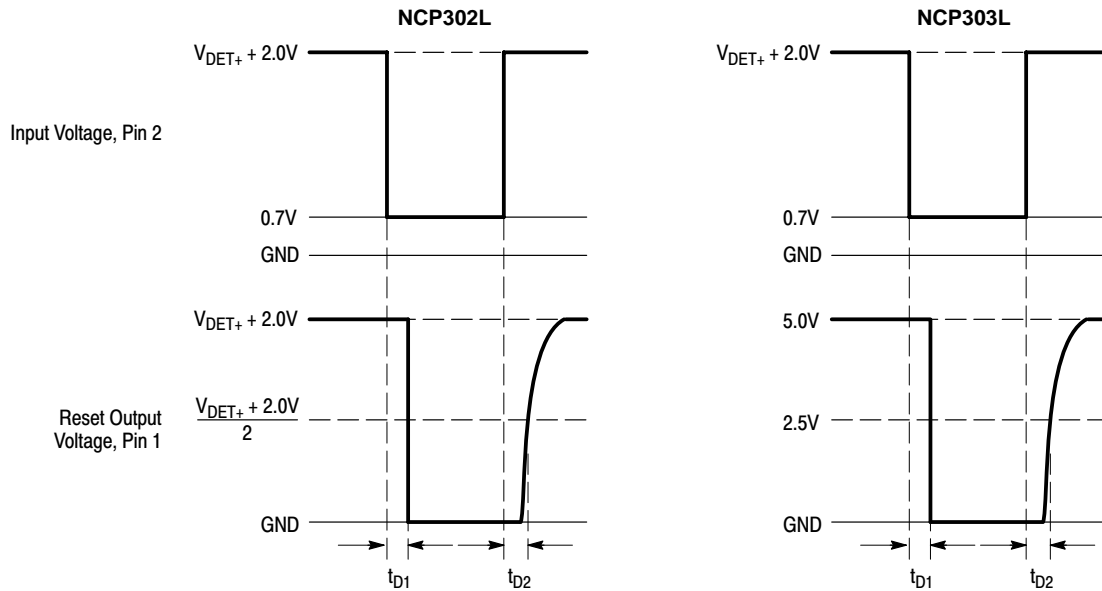

NCP302 and NCP303 series are measured with 10 pF capacitive load. NCP303 has an additional 470 k pullup resistor connected from the reset output to +5.0 V. Reset output voltage waveforms are shown for the active low 'L' devices. For active high 'H' devices, the reset output voltage waveforms are inverted. Output time delay t_{D1} and t_{D2} are dependent upon the delay capacitance. Refer to Figures 11, 12, and 13. The upper detector threshold, V_{DET+} is the sum of the lower detector threshold, V_{DET-} plus the input hysteresis, V_{HYS} .

Figure 1. Measurement Conditions for t_{D1} and t_{D2}

NCP302, NCP303

Table 1. ELECTRICAL CHARACTERISTIC TABLE FOR 0.9 – 4.9 V

NCP302 Series	Detector Threshold			Detector Threshold Hysteresis			Supply Current		Nch Sink Current		Pch Source Current
							V _{in} Low	V _{in} High	V _{in} Low	V _{in} High	
Part Number	V _{DET-} (V)			V _{HYS} (V)			I _{in} (μA) (1)	I _{in} (μA) (2)	I _{OUT} (mA) (3)	I _{OUT} (mA) (4)	I _{OUT} (mA) (5)
	Min	Typ	Max	Min	Typ	Max	Typ	Typ	Typ	Typ	Typ
NCP302(L/H)SN09T1	0.882	0.9	0.918	0.027	0.045	0.063	0.3	0.5	0.05	0.5	2.0
NCP302(L/H)SN10T1	0.980	1.0	1.020	0.030	0.050	0.070					
NCP302(L/H)SN11T1	1.078	1.1	1.122	0.033	0.055	0.077					
NCP302(L/H)SN12T1	1.176	1.2	1.224	0.036	0.060	0.084					
NCP302(L/H)SN13T1	1.274	1.3	1.326	0.039	0.065	0.091					
NCP302(L/H)SN14T1	1.372	1.4	1.428	0.042	0.070	0.098					
NCP302(L/H)SN15T1	1.470	1.5	1.530	0.045	0.075	0.105					
NCP302(L/H)SN16T1	1.568	1.6	1.632	0.048	0.080	0.112					
NCP302(L/H)SN17T1	1.666	1.7	1.734	0.051	0.085	0.119					
NCP302(L/H)SN18T1	1.764	1.8	1.836	0.054	0.090	0.126					
NCP302(L/H)SN19T1	1.862	1.9	1.938	0.057	0.095	0.133					
NCP302(L/H)SN20T1	1.960	2.0	2.040	0.060	0.100	0.140					
NCP302(L/H)SN21T1	2.058	2.1	2.142	0.063	0.105	0.147					
NCP302(L/H)SN22T1	2.156	2.2	2.244	0.066	0.110	0.154					
NCP302(L/H)SN23T1	2.254	2.3	2.346	0.069	0.115	0.161					
NCP302(L/H)SN24T1	2.352	2.4	2.448	0.072	0.120	0.168					
NCP302(L/H)SN25T1	2.450	2.5	2.550	0.075	0.125	0.175					
NCP302(L/H)SN26T1	2.548	2.6	2.652	0.078	0.130	0.182					
NCP302(L/H)SN27T1	2.646	2.7	2.754	0.081	0.135	0.189					
NCP302(L/H)SN28T1	2.744	2.8	2.856	0.084	0.140	0.196					
NCP302(L/H)SN29T1	2.842	2.9	2.958	0.087	0.145	0.203					
NCP302(L/H)SN30T1	2.940	3.0	3.060	0.090	0.150	0.210					
NCP302(L/H)SN31T1	3.038	3.1	3.162	0.093	0.155	0.217					
NCP302(L/H)SN32T1	3.136	3.2	3.264	0.096	0.160	0.224					
NCP302(L/H)SN33T1	3.234	3.3	3.366	0.099	0.165	0.231					
NCP302(L/H)SN34T1	3.332	3.4	3.468	0.102	0.170	0.238					
NCP302(L/H)SN35T1	3.430	3.5	3.570	0.105	0.175	0.245					
NCP302(L/H)SN36T1	3.528	3.6	3.672	0.108	0.180	0.252					
NCP302(L/H)SN37T1	3.626	3.7	3.774	0.111	0.185	0.259					
NCP302(L/H)SN38T1	3.724	3.8	3.876	0.114	0.190	0.266					
NCP302(L/H)SN39T1	3.822	3.9	3.978	0.117	0.195	0.273					
NCP302(L/H)SN40T1	3.920	4.0	4.080	0.120	0.200	0.280	0.4	0.6	0.05	0.5	3.0
NCP302(L/H)SN41T1	4.018	4.1	4.182	0.123	0.205	0.287					
NCP302(L/H)SN42T1	4.116	4.2	4.284	0.126	0.210	0.294					
NCP302(L/H)SN43T1	4.214	4.3	4.386	0.129	0.215	0.301					
NCP302(L/H)SN44T1	4.312	4.4	4.488	0.132	0.220	0.308					
NCP302(L/H)SN45T1	4.410	4.5	4.590	0.135	0.225	0.315					
NCP302(L/H)SN46T1	4.508	4.6	4.692	0.138	0.230	0.322					
NCP302(L/H)SN47T1	4.606	4.7	4.794	0.141	0.235	0.329					
NCP302(L/H)SN48T1	4.704	4.8	4.896	0.144	0.240	0.336					
NCP302(L/H)SN49T1	4.802	4.9	4.998	0.147	0.245	0.343					

(1) Condition 1: 0.9 – 2.9 V, V_{in} = V_{DET-} – 0.10 V; 3.0 – 3.9 V, V_{in} = V_{DET-} – 0.13 V; 4.0 – 4.9 V, V_{in} = V_{DET-} – 0.16 V

(2) Condition 2: 0.9 – 4.9 V, V_{in} = V_{DET-} + 2.0 V

(3) Condition 3: 0.9 – 4.9 V, V_{in} = 0.7 V, V_{OUT} = 0.05 V, Active Low 'L' Suffix Devices

(4) Condition 4: 0.9 – 1.0 V, V_{in} = 0.85 V, V_{OUT} = 0.5 V; 1.1 – 1.5 V, V_{in} = 1.0 V, V_{OUT} = 0.5 V; 1.6 – 4.9 V, V_{in} = 1.5 V, V_{OUT} = 0.5 V, Active Low 'L' Suffix Devices

(5) Condition 5: 0.9 – 3.9 V, V_{in} = 4.5 V, V_{OUT} = 2.4 V; 4.0 – 4.9 V, V_{in} = 8.0 V, V_{OUT} = 5.9 V

NCP302, NCP303

Table 2. ELECTRICAL CHARACTERISTIC TABLE FOR 0.9 – 4.9 V

NCP303 Series	Detector Threshold			Detector Threshold Hysteresis			Supply Current		Nch Sink Current		
							V _{in} Low	V _{in} High	V _{in} Low	V _{in} High	
Part Number	V _{DET-} (V)			V _{HYS} (V)			I _{in} (μA) (1)	I _{in} (μA) (2)	I _{OUT} (mA) (3)	I _{OUT} (mA) (4)	
	Min	Typ	Max	Min	Typ	Max	Typ	Typ	Typ	Typ	
NCP303LSN09T1	0.882	0.9	0.918	0.027	0.045	0.063	0.3	0.5	0.05	0.5	
NCP303LSN10T1	0.980	1.0	1.020	0.030	0.050	0.070				1.0	
NCP303LSN11T1	1.078	1.1	1.122	0.033	0.055	0.077					
NCP303LSN12T1	1.176	1.2	1.224	0.036	0.060	0.084					
NCP303LSN13T1	1.274	1.3	1.326	0.039	0.065	0.091					
NCP303LSN14T1	1.372	1.4	1.428	0.042	0.070	0.098					
NCP303LSN15T1	1.470	1.5	1.530	0.045	0.075	0.105					
NCP303LSN16T1	1.568	1.6	1.632	0.048	0.080	0.112					2.0
NCP303LSN17T1	1.666	1.7	1.734	0.051	0.085	0.119					
NCP303LSN18T1	1.764	1.8	1.836	0.054	0.090	0.126					
NCP303LSN19T1	1.862	1.9	1.938	0.057	0.095	0.133					
NCP303LSN20T1	1.960	2.0	2.040	0.060	0.100	0.140					
NCP303LSN21T1	2.058	2.1	2.142	0.063	0.105	0.147					
NCP303LSN22T1	2.156	2.2	2.244	0.066	0.110	0.154					
NCP303LSN23T1	2.254	2.3	2.346	0.069	0.115	0.161					
NCP303LSN24T1	2.352	2.4	2.448	0.072	0.120	0.168					
NCP303LSN25T1	2.450	2.5	2.550	0.075	0.125	0.175					
NCP303LSN26T1	2.548	2.6	2.652	0.078	0.130	0.182					
NCP303LSN27T1	2.646	2.7	2.754	0.081	0.135	0.189					
NCP303LSN28T1	2.744	2.8	2.856	0.084	0.140	0.196					
NCP303LSN29T1	2.842	2.9	2.958	0.087	0.145	0.203					
NCP303LSN30T1	2.940	3.0	3.060	0.090	0.150	0.210					
NCP303LSN31T1	3.038	3.1	3.162	0.093	0.155	0.217					
NCP303LSN32T1	3.136	3.2	3.264	0.096	0.160	0.224					
NCP303LSN33T1	3.234	3.3	3.366	0.099	0.165	0.231					
NCP303LSN34T1	3.332	3.4	3.468	0.102	0.170	0.238					
NCP303LSN35T1	3.430	3.5	3.570	0.105	0.175	0.245					
NCP303LSN36T1	3.528	3.6	3.672	0.108	0.180	0.252					
NCP303LSN37T1	3.626	3.7	3.774	0.111	0.185	0.259					
NCP303LSN38T1	3.724	3.8	3.876	0.114	0.190	0.266					
NCP303LSN39T1	3.822	3.9	3.978	0.117	0.195	0.273					
NCP303LSN40T1	3.920	4.0	4.080	0.120	0.200	0.280			0.4	0.6	
NCP303LSN41T1	4.018	4.1	4.182	0.123	0.205	0.287					
NCP303LSN42T1	4.116	4.2	4.284	0.126	0.210	0.294					
NCP303LSN43T1	4.214	4.3	4.386	0.129	0.215	0.301					
NCP303LSN44T1	4.312	4.4	4.488	0.132	0.220	0.308					
NCP303LSN45T1	4.410	4.5	4.590	0.135	0.225	0.315					
NCP303LSN46T1	4.508	4.6	4.692	0.138	0.230	0.322					
NCP303LSN47T1	4.606	4.7	4.794	0.141	0.235	0.329					
NCP303LSN48T1	4.704	4.8	4.896	0.144	0.240	0.336					
NCP303LSN49T1	4.802	4.9	4.998	0.147	0.245	0.343					

(1) Condition 1: 0.9 – 2.9 V, V_{in} = V_{DET-} – 0.10 V; 3.0 – 3.9 V, V_{in} = V_{DET-} – 0.13 V; 4.0 – 4.9 V, V_{in} = V_{DET-} – 0.16 V
(2) Condition 2: 0.9 – 4.9 V, V_{in} = V_{DET-} + 2.0 V
(3) Condition 3: 0.9 – 4.9 V, V_{in} = 0.7 V, V_{OUT} = 0.05 V, Active Low 'L' Suffix Devices
(4) Condition 4: 0.9 – 1.0 V, V_{in} = 0.85 V, V_{OUT} = 0.5 V; 1.1 – 1.5 V, V_{in} = 1.0 V, V_{OUT} = 0.5 V; 1.6 – 4.9 V, V_{in} = 1.5 V, V_{OUT} = 0.5 V, Active Low 'L' Suffix Devices

NCP302, NCP303

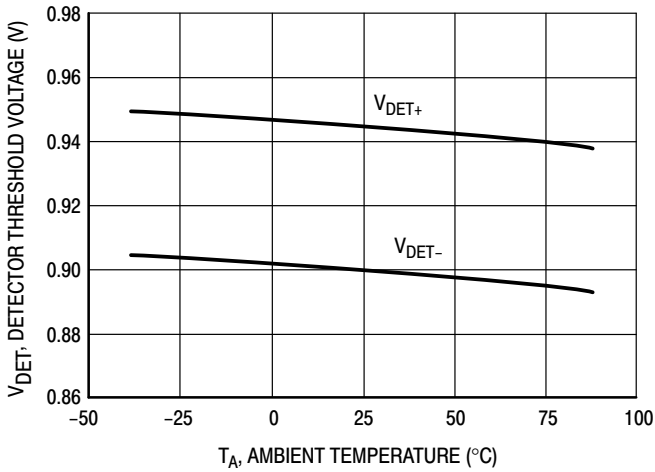

Figure 2. NCP302/3 Series 0.9 V
Detector Threshold Voltage versus Temperature

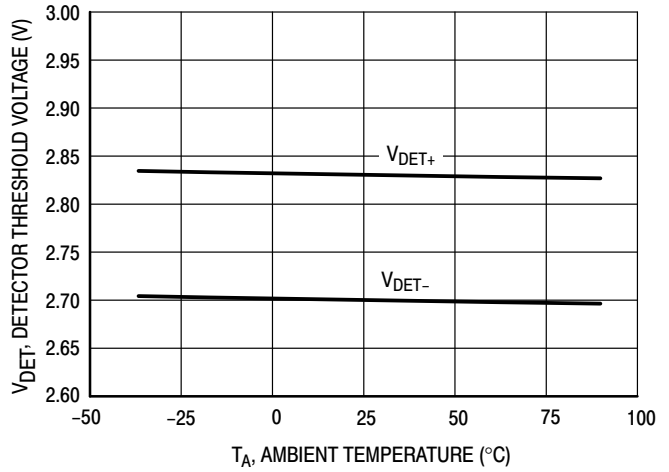

Figure 3. NCP302/3 Series 2.7 V
Detector Threshold Voltage versus Temperature

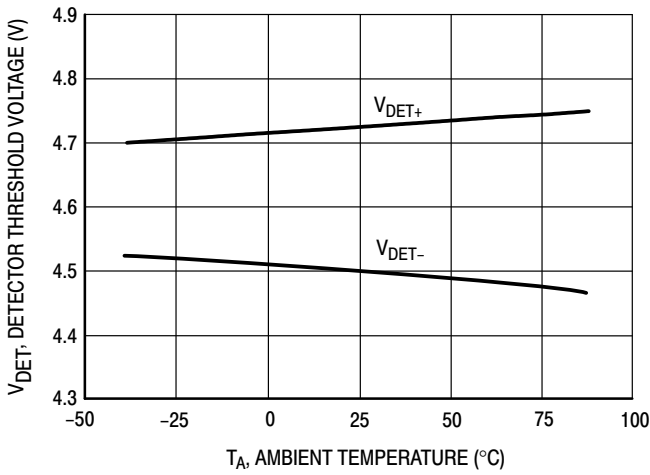

Figure 4. NCP302/3 Series 4.5 V
Detector Threshold Voltage versus Temperature

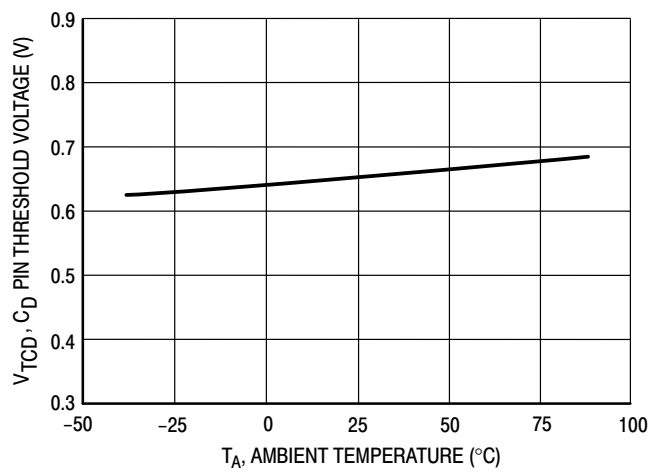

Figure 5. NCP302/3 Series 0.9 V
 C_D Pin Threshold Voltage versus Temperature

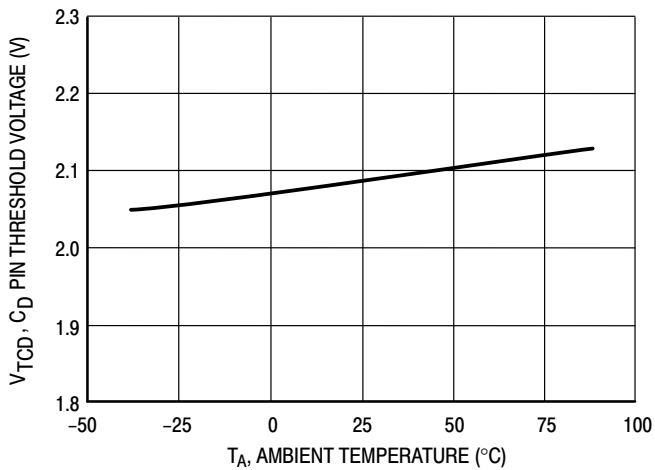

Figure 6. NCP302/3 Series 2.7 V
 C_D Pin Threshold Voltage versus Temperature

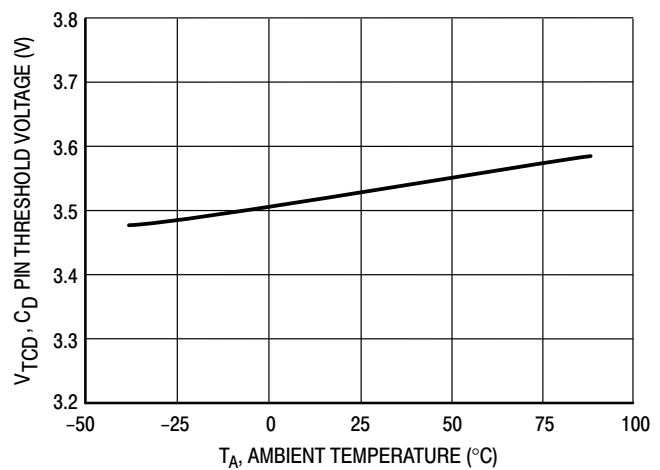

Figure 7. NCP302/3 Series 4.5 V
 C_D Pin Threshold Voltage versus Temperature

NCP302, NCP303

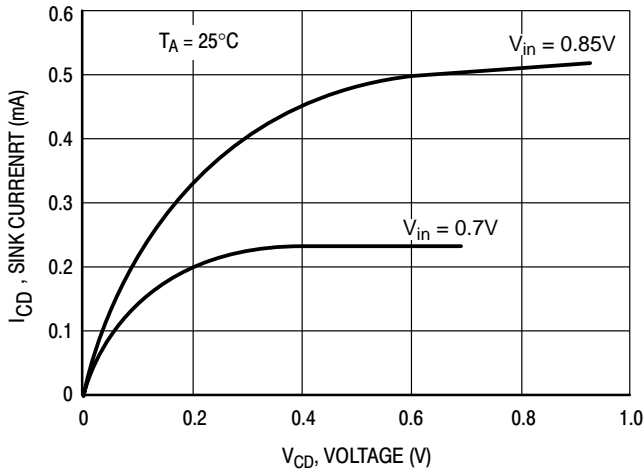

Figure 8. NCP302/3 Series 0.9 V
C_D Pin Sink Current versus C_D Pin Voltage

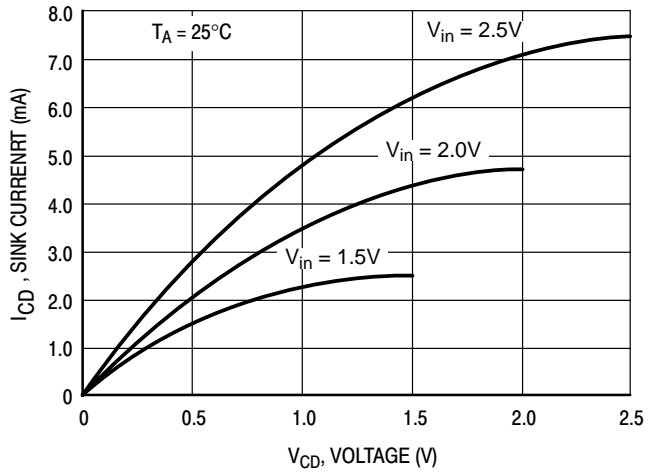

Figure 9. NCP302/3 Series 2.7 V
C_D Pin Sink Current versus C_D Pin Voltage

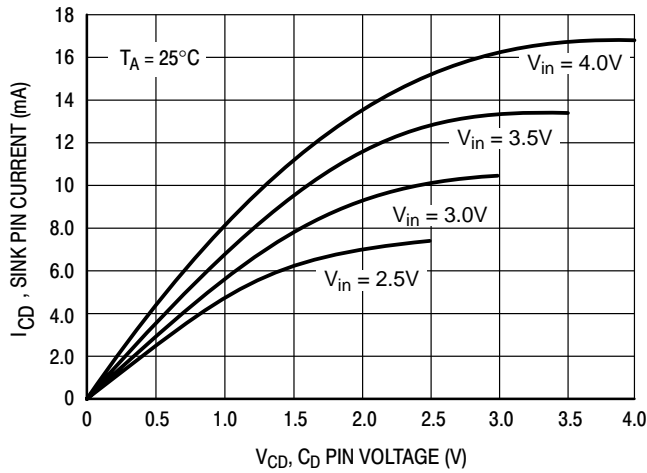

Figure 10. NCP302/3 Series 4.5 V
C_D Pin Sink Current versus C_D Pin Voltage

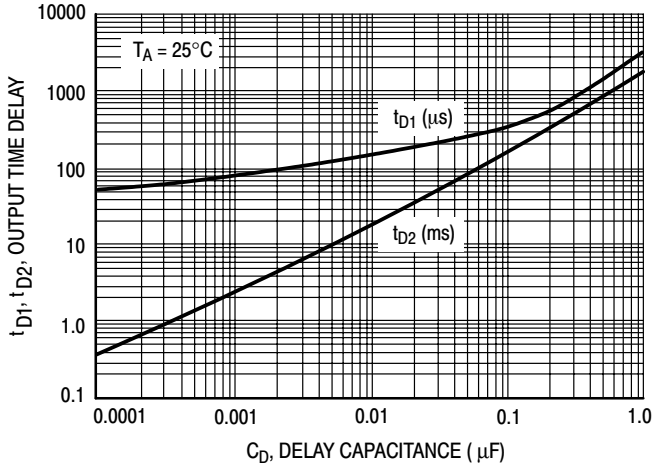

Figure 11. NCP302/3 Series 0.9 V
Output Time Delay versus Delay Capacitance

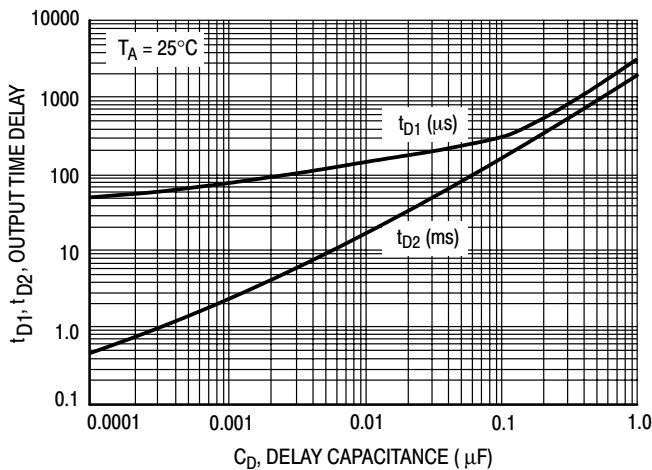

Figure 12. NCP302/3 Series 2.7 V
Output Time Delay versus Delay Capacitance

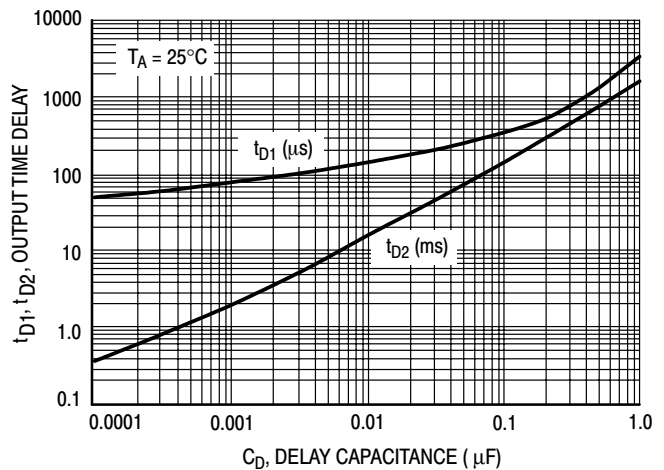

Figure 13. NCP302/3 Series 4.5 V
Output Time Delay versus Delay Capacitance

NCP302, NCP303

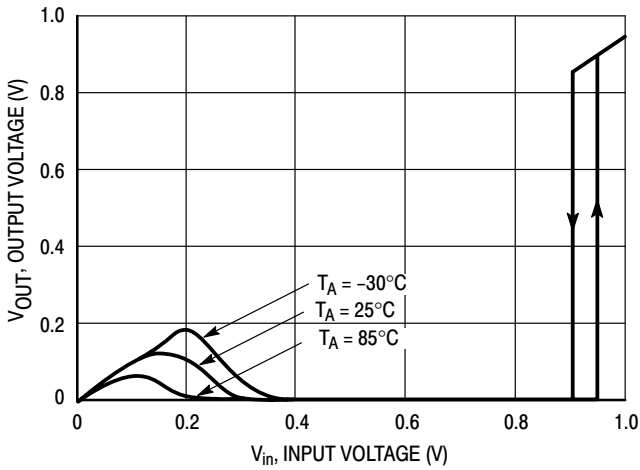

Figure 14. NCP302L/3L Series 0.9 V Output Voltage versus Input Voltage

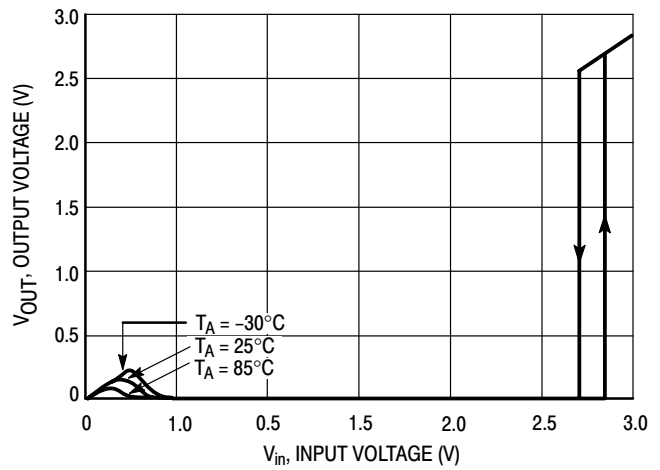

Figure 15. NCP302L/3L Series 2.7 V Output Voltage versus Input Voltage

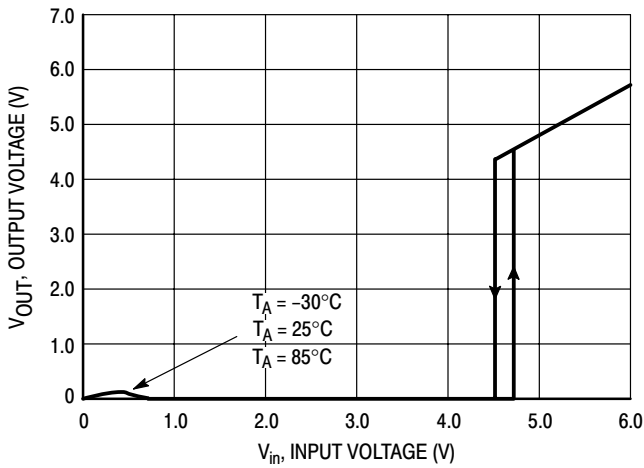

Figure 16. NCP302L/3L Series 4.5 V Output Voltage versus Input Voltage

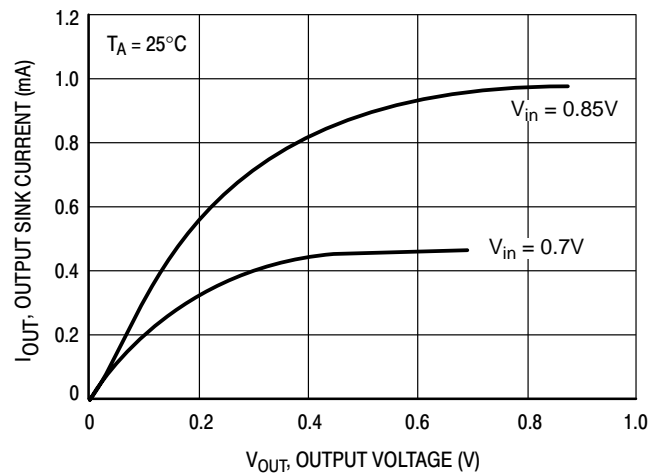

Figure 17. NCP302L/3L Series 0.9 V Reset Output Sink Current versus Output Voltage

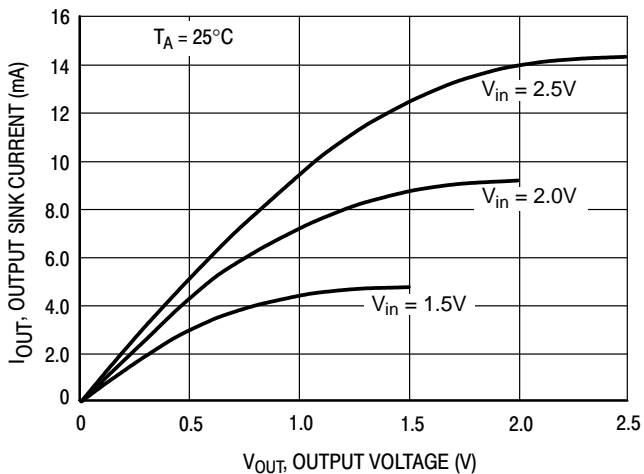

Figure 18. NCP302L/3L Series 2.7 V Reset Output Sink Current versus Output Voltage

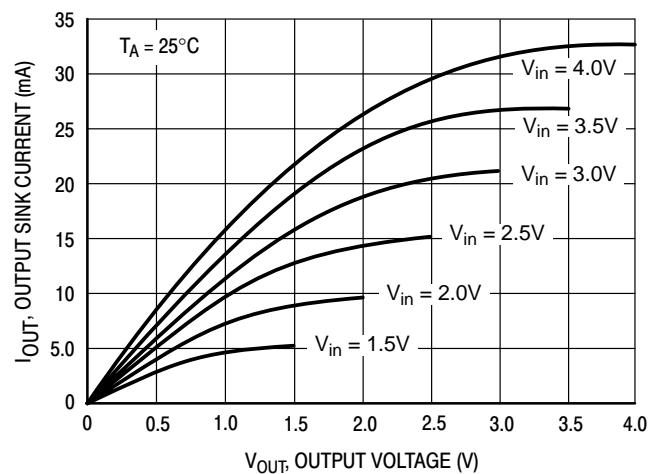

Figure 19. NCP302L/3L Series 4.5 V Reset Output Sink Current versus Output Voltage

NCP302, NCP303

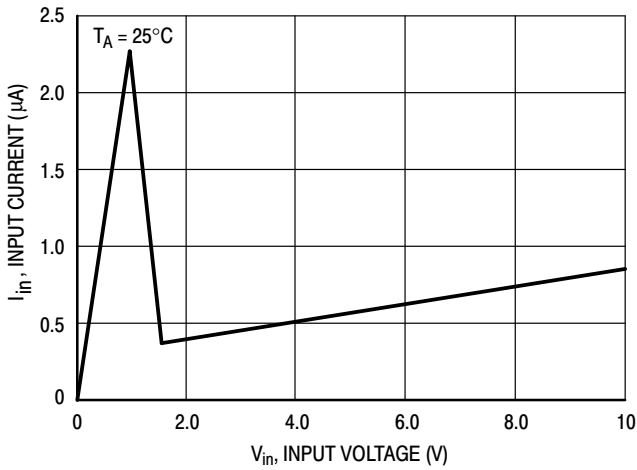

Figure 20. NCP302/3 Series 0.9 V Input Current versus Input Voltage

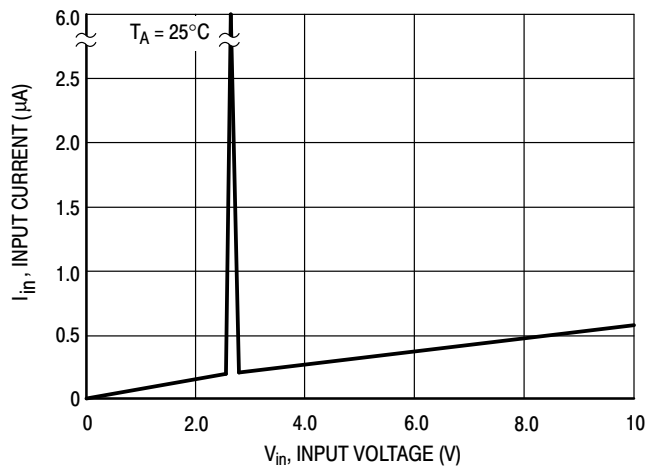

Figure 21. NCP302/3 Series 2.7 V Input Current versus Input Voltage

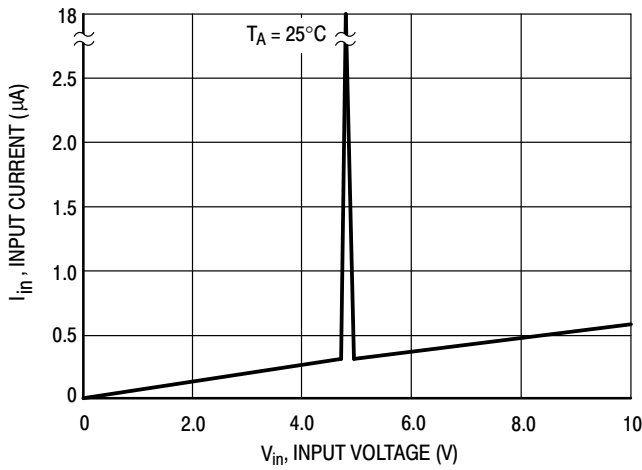

Figure 22. NCP302/3 Series 4.5 V Input Current versus Input Voltage

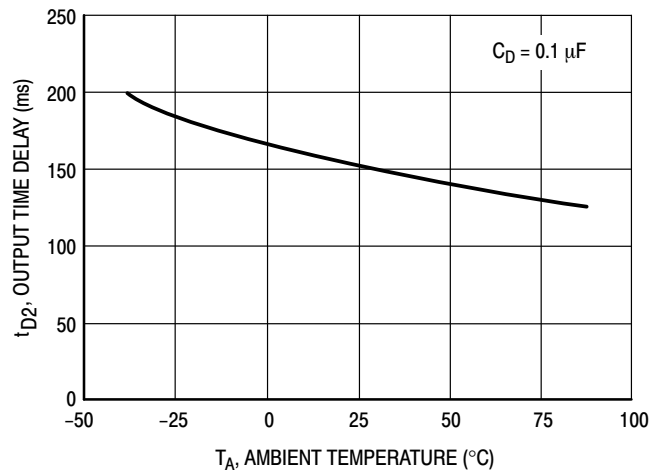

Figure 23. NCP302/3 Series 0.9 V Time Delay versus Temperature

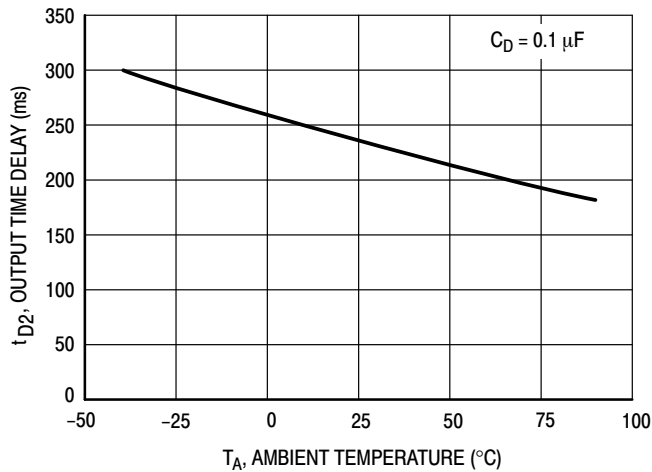

Figure 24. NCP302/3 Series 2.7 V Time Delay versus Temperature

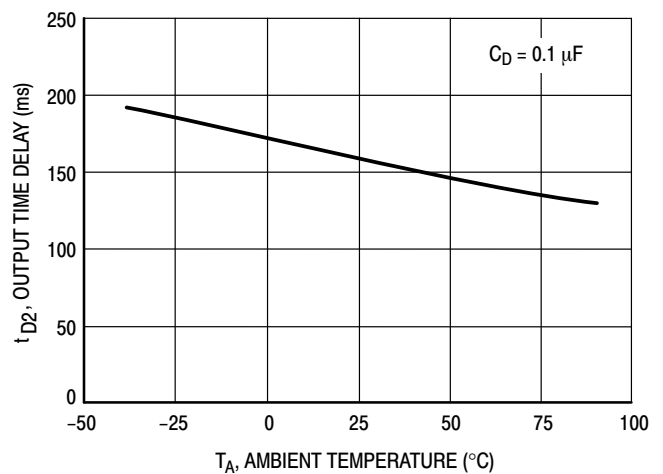

Figure 25. NCP302/3 Series 4.5 V Time Delay versus Temperature

NCP302, NCP303

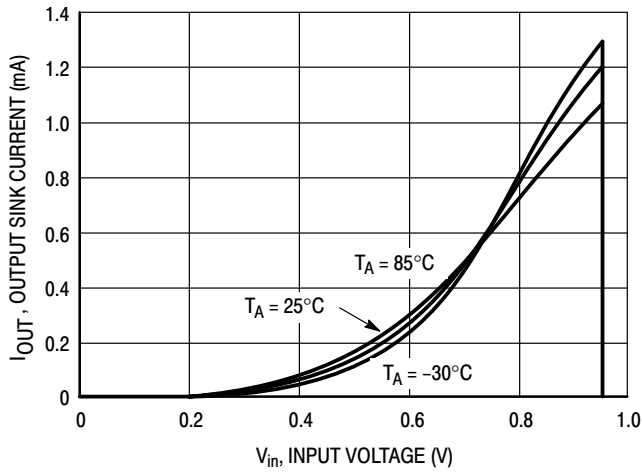

Figure 26. NCP302L/3L Series 0.9 V Reset Output Sink Current versus Input Voltage

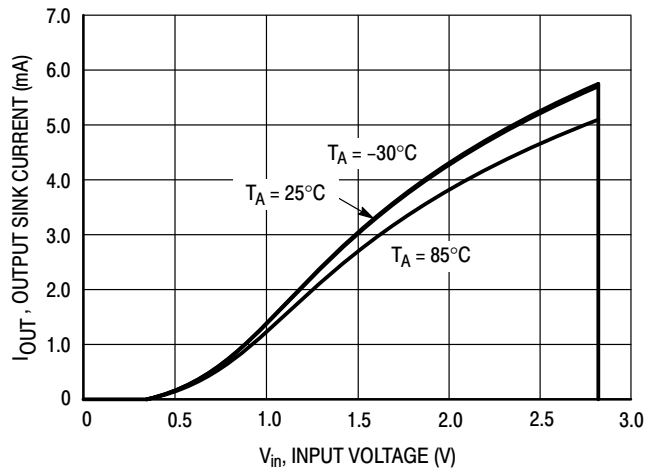

Figure 27. NCP302L/3L Series 2.7 V Reset Output Sink Current versus Input Voltage

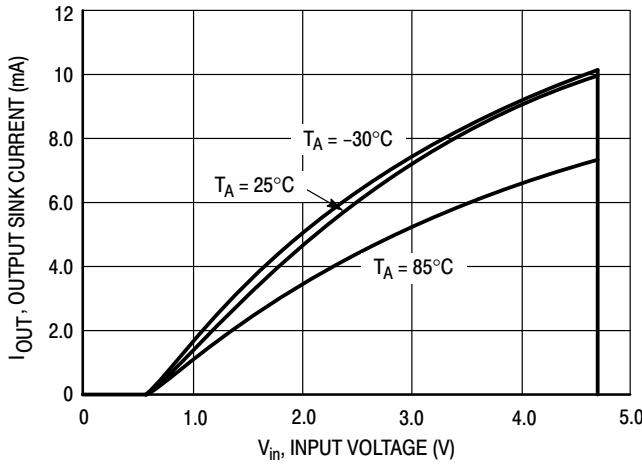

Figure 28. NCP302L/3L Series 4.5 V Reset Output Sink Current versus Input Voltage

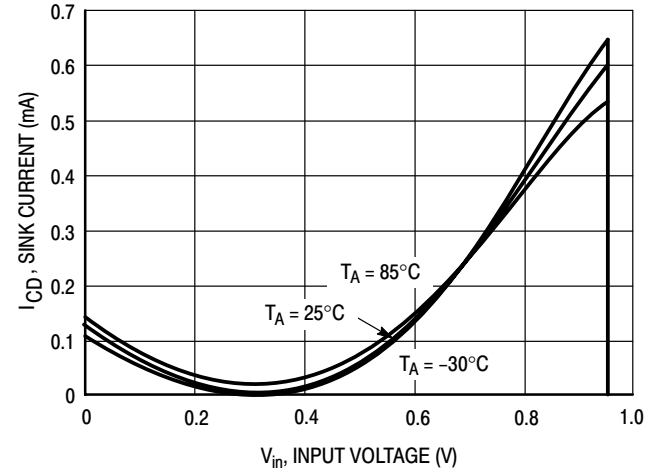

Figure 29. NCP302/3 Series 0.9 V C_D Pin Sink Current versus Input Voltage

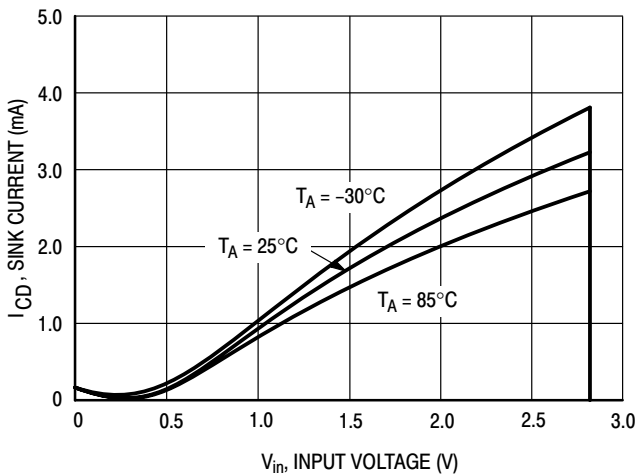

Figure 30. NCP302/3 Series 2.7 V C_D Pin Sink Current versus Input Voltage

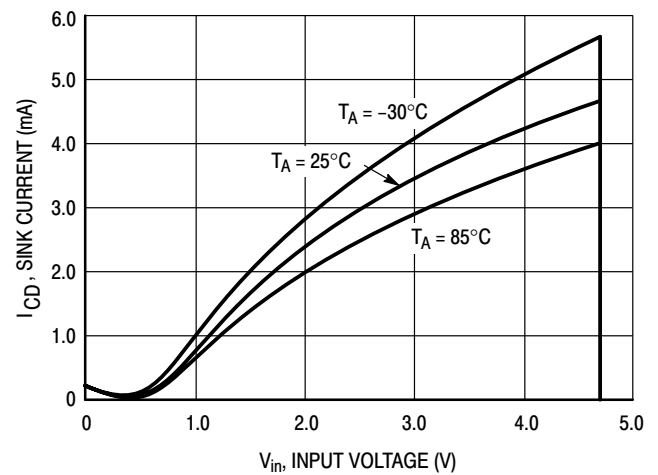

Figure 31. NCP302/3 Series 4.5 V C_D Pin Sink Current versus Input Voltage

NCP302, NCP303

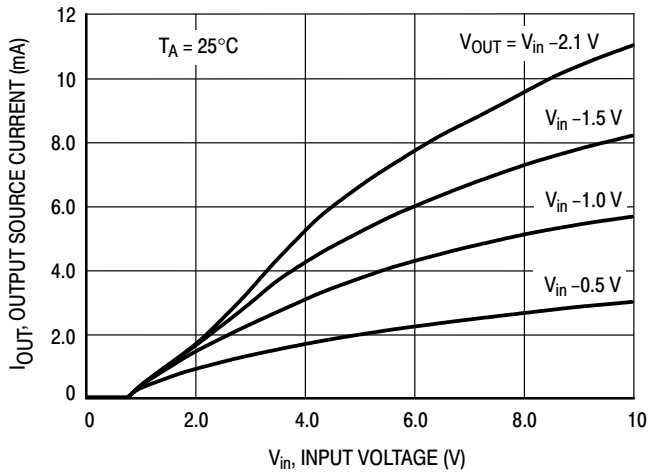

Figure 32. NCP302L Series 0.9 V
Reset Output Source Current versus Input Voltage

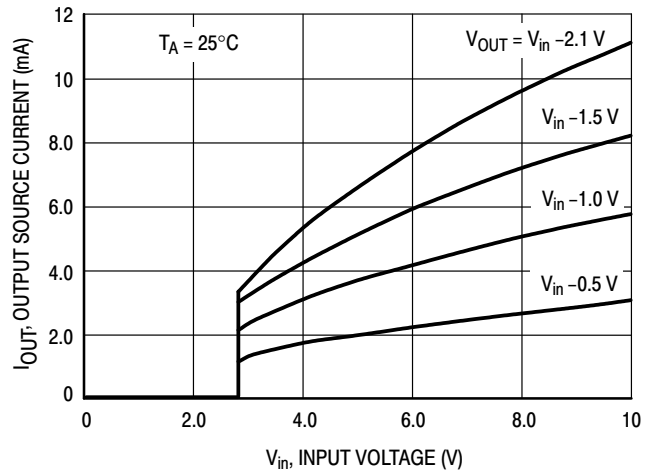

Figure 33. NCP302L Series 2.7 V
Reset Output Source Current versus Input Voltage

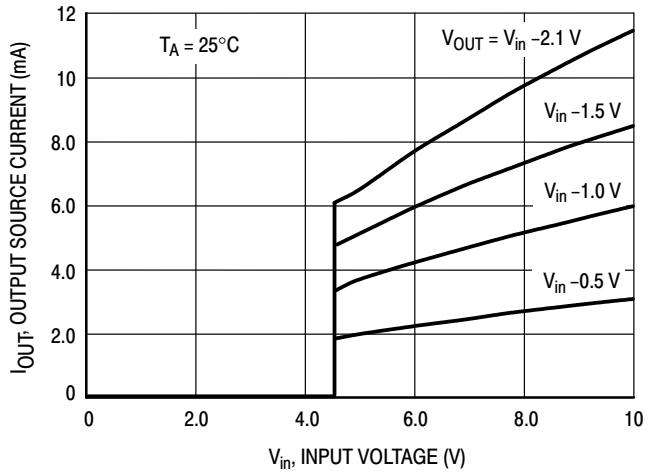

Figure 34. NCP302L Series 4.5 V
Reset Output Source Current versus Input Voltage

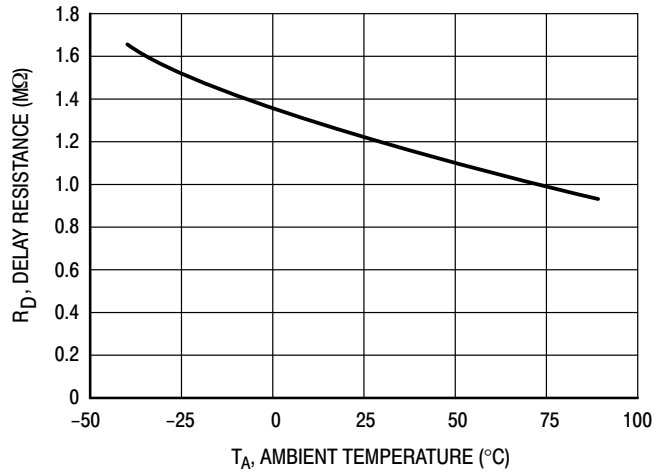

Figure 35. NCP302/3 Series
Delay Resistance versus Temperature

OPERATING DESCRIPTION

The NCP302 and NCP303 series devices consist of a precision voltage detector that drives a time delay generator. Figures 36 and 37 show a timing diagram and a typical application. Initially consider that input voltage V_{in} is at a nominal level and it is greater than the voltage detector upper threshold (V_{DET+}). The voltage at Pin 5 and capacitor C_D will be at the same level as V_{in} , and the reset output (Pin 1) will be in the high state for active low devices, or in the low state for active high devices. If there is a power interruption and V_{in} becomes significantly deficient, it will fall below the lower detector threshold (V_{DET-}) and the external time delay capacitor C_D will be immediately discharged by an internal N-channel MOSFET that connects to Pin 5. This sequence of events causes the Reset output to be in the low state for active low devices, or in the high state for active high devices. After completion of the power interruption, V_{in} will again return to its nominal level and become greater than the V_{DET+} . The voltage detector will turn off the N-channel MOSFET and allow pullup resistor R_D to charge external capacitor C_D , thus creating a programmable delay for releasing the reset signal. When the voltage at Pin 5 exceeds the inverter/buffer threshold, typically $0.675 \cdot V_{in}$, the reset output will revert back to its original state. The reset output time delay versus capacitance is shown in Figures 11 through 13. The voltage detector and inverter/buffer have built-in hysteresis to prevent erratic reset operation.

Although these device series are specifically designed for use as reset controllers in portable microprocessor based systems, they offer a cost-effective solution in numerous applications where precise voltage monitoring and time delay are required. Figures 37 through 39 show various application examples.

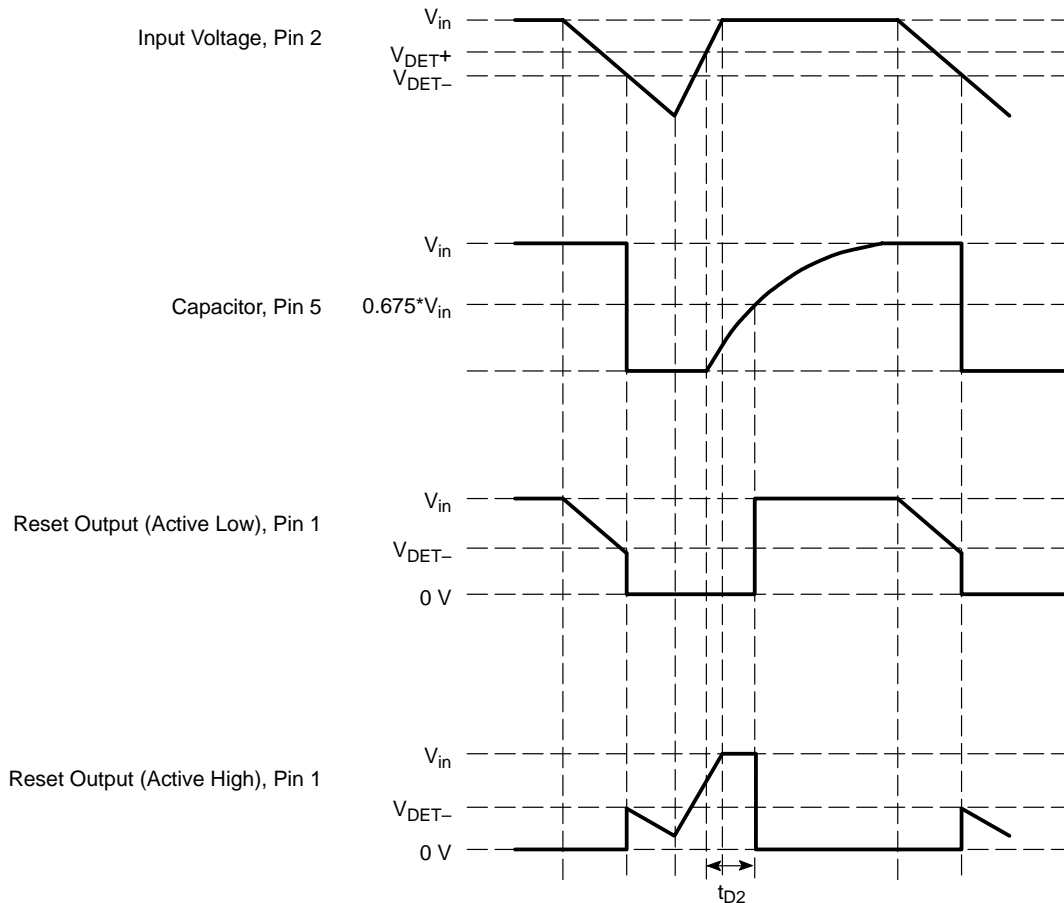

Figure 36. Timing Waveforms

NCP302, NCP303

APPLICATION CIRCUIT INFORMATION

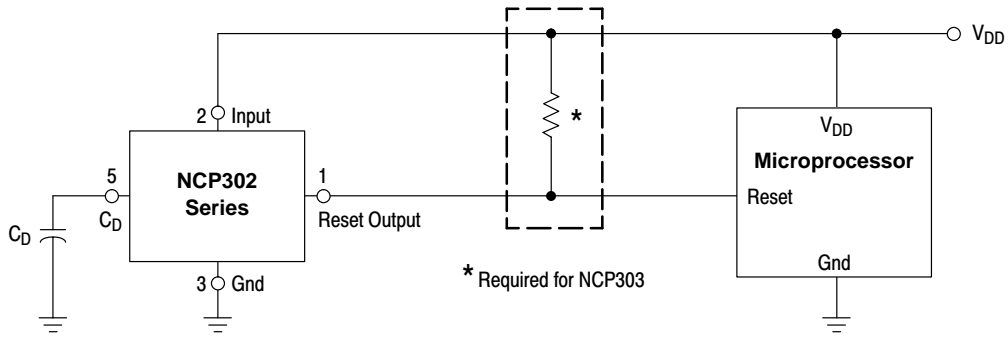

Figure 37. Microprocessor Reset Circuit (NCP302 and NCP303 Series)

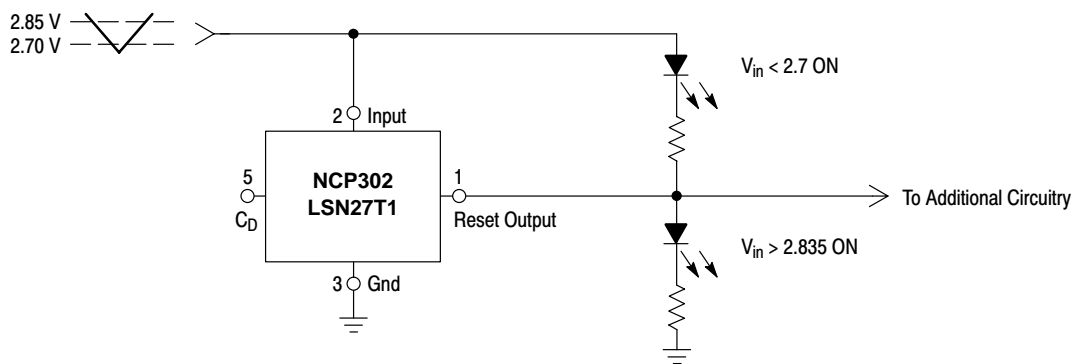

Figure 38. Battery Charge Indicator (NCP302 Series)

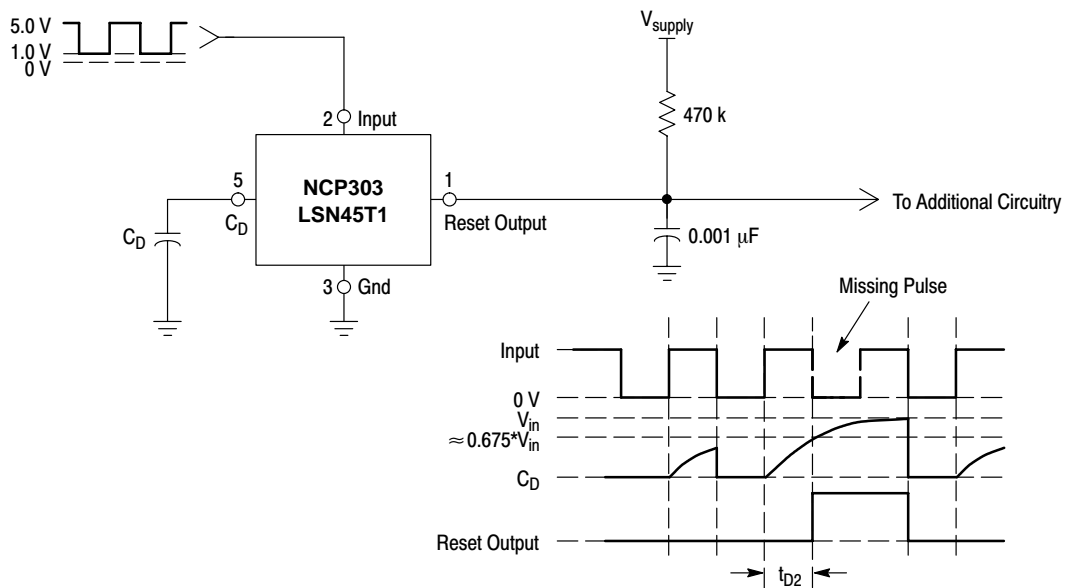
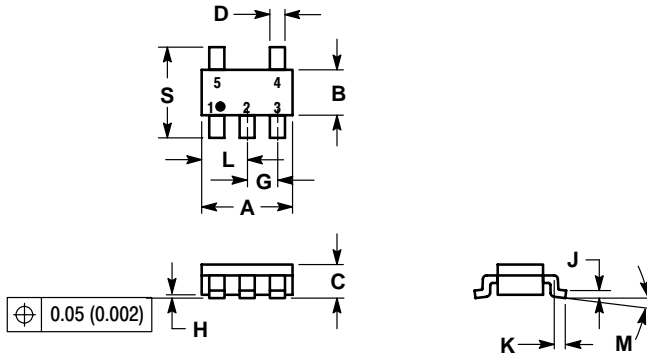

Figure 39. Missing Pulse Detector or Frequency Detector (NCP303L)

NCP302, NCP303

PACKAGE DIMENSIONS

TSOP-5
 SN SUFFIX
 PLASTIC PACKAGE
 CASE 483-01
 ISSUE A



NOTES:

1. DIMENSIONING AND TOLERANCING PER ANSI Y14.5M, 1982.
2. CONTROLLING DIMENSION: MILLIMETER.
3. MAXIMUM LEAD THICKNESS INCLUDES LEAD FINISH THICKNESS. MINIMUM LEAD THICKNESS IS THE MINIMUM THICKNESS OF BASE MATERIAL.

DIM	MILLIMETERS		INCHES	
	MIN	MAX	MIN	MAX
A	2.90	3.10	0.1142	0.1220
B	1.30	1.70	0.0512	0.0669
C	0.90	1.10	0.0354	0.0433
D	0.25	0.50	0.0098	0.0197
G	0.85	1.00	0.0335	0.0413
H	0.013	0.100	0.0005	0.0040
J	0.10	0.26	0.0040	0.0102
K	0.20	0.60	0.0079	0.0236
L	1.25	1.55	0.0493	0.0610
M	0°	10°	0°	10°
S	2.50	3.00	0.0985	0.1181

NCP302, NCP303

MINIMUM RECOMMENDED FOOTPRINT FOR SURFACE MOUNTED APPLICATIONS

Surface mount board layout is a critical portion of the total design. The footprint for the semiconductor packages must be the correct size to insure proper solder connection

interface between the board and the package. With the correct pad geometry, the packages will self align when subjected to a solder reflow process.

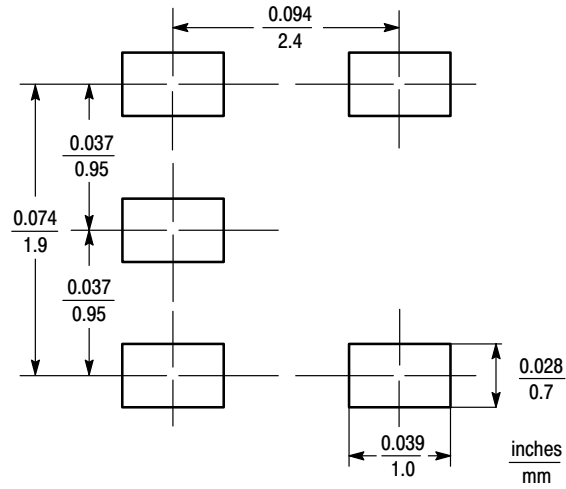

TSOP-5

(Footprint Compatible with SOT23-5)

Notes

NCP302, NCP303

ON Semiconductor and  are trademarks of Semiconductor Components Industries, LLC (SCILLC). SCILLC reserves the right to make changes without further notice to any products herein. SCILLC makes no warranty, representation or guarantee regarding the suitability of its products for any particular purpose, nor does SCILLC assume any liability arising out of the application or use of any product or circuit, and specifically disclaims any and all liability, including without limitation special, consequential or incidental damages. "Typical" parameters which may be provided in SCILLC data sheets and/or specifications can and do vary in different applications and actual performance may vary over time. All operating parameters, including "Typicals" must be validated for each customer application by customer's technical experts. SCILLC does not convey any license under its patent rights nor the rights of others. SCILLC products are not designed, intended, or authorized for use as components in systems intended for surgical implant into the body, or other applications intended to support or sustain life, or for any other application in which the failure of the SCILLC product could create a situation where personal injury or death may occur. Should Buyer purchase or use SCILLC products for any such unintended or unauthorized application, Buyer shall indemnify and hold SCILLC and its officers, employees, subsidiaries, affiliates, and distributors harmless against all claims, costs, damages, and expenses, and reasonable attorney fees arising out of, directly or indirectly, any claim of personal injury or death associated with such unintended or unauthorized use, even if such claim alleges that SCILLC was negligent regarding the design or manufacture of the part. SCILLC is an Equal Opportunity/Affirmative Action Employer.

PUBLICATION ORDERING INFORMATION

NORTH AMERICA Literature Fulfillment:

Literature Distribution Center for ON Semiconductor
P.O. Box 5163, Denver, Colorado 80217 USA
Phone: 303-675-2175 or 800-344-3860 Toll Free USA/Canada
Fax: 303-675-2176 or 800-344-3867 Toll Free USA/Canada
Email: ONlit@hibbertco.com
Fax Response Line: 303-675-2167 or 800-344-3810 Toll Free USA/Canada

N. American Technical Support: 800-282-9855 Toll Free USA/Canada

EUROPE: LDC for ON Semiconductor – European Support

German Phone: (+1) 303-308-7140 (Mon-Fri 2:30pm to 7:00pm CET)
Email: ONlit-german@hibbertco.com
French Phone: (+1) 303-308-7141 (Mon-Fri 2:00pm to 7:00pm CET)
Email: ONlit-french@hibbertco.com
English Phone: (+1) 303-308-7142 (Mon-Fri 12:00pm to 5:00pm GMT)
Email: ONlit@hibbertco.com

EUROPEAN TOLL-FREE ACCESS*: 00-800-4422-3781

*Available from Germany, France, Italy, UK

CENTRAL/SOUTH AMERICA:

Spanish Phone: 303-308-7143 (Mon-Fri 8:00am to 5:00pm MST)
Email: ONlit-spanish@hibbertco.com

ASIA/PACIFIC: LDC for ON Semiconductor – Asia Support

Phone: 303-675-2121 (Tue-Fri 9:00am to 1:00pm, Hong Kong Time)
Toll Free from Hong Kong & Singapore:
001-800-4422-3781
Email: ONlit-asia@hibbertco.com

JAPAN: ON Semiconductor, Japan Customer Focus Center
4-32-1 Nishi-Gotanda, Shinagawa-ku, Tokyo, Japan 141-0031

Phone: 81-3-5740-2745
Email: r14525@onsemi.com

ON Semiconductor Website: <http://onsemi.com>

For additional information, please contact your local Sales Representative.