

MMBZ5221BLT1 Series

Preferred Device

Zener Voltage Regulators

225 mW SOT-23 Surface Mount

This series of Zener diodes is offered in the convenient, surface mount plastic SOT-23 package. These devices are designed to provide voltage regulation with minimum space requirement. They are well suited for applications such as cellular phones, hand held portables, and high density PC boards.

Features

- Pb-Free Packages are Available
- 225 mW Rating on FR-4 or FR-5 Board
- Zener Voltage Range – 2.4 V to 91 V
- Package Designed for Optimal Automated Board Assembly
- Small Package Size for High Density Applications
- ESD Rating of Class 3 (>16 KV) per Human Body Model

Mechanical Characteristics

CASE: Void-free, transfer-molded, thermosetting plastic case

FINISH: Corrosion resistant finish, easily solderable

MAXIMUM CASE TEMPERATURE FOR SOLDERING PURPOSES:

260°C for 10 Seconds

POLARITY: Cathode indicated by polarity band

FLAMMABILITY RATING: UL 94 V-0

MAXIMUM RATINGS

Rating	Symbol	Max	Unit
Total Power Dissipation on FR-5 Board, (Note 1) @ $T_A = 25^\circ\text{C}$ Derated above 25°C	P_D	225 1.8	mW mW/ $^\circ\text{C}$
Thermal Resistance, Junction-to-Ambient	$R_{\theta JA}$	556	$^\circ\text{C}/\text{W}$
Total Power Dissipation on Alumina Substrate, (Note 2) @ $T_A = 25^\circ\text{C}$ Derated above 25°C	P_D	300 2.4	mW mW/ $^\circ\text{C}$
Thermal Resistance, Junction-to-Ambient	$R_{\theta JA}$	417	$^\circ\text{C}/\text{W}$
Junction and Storage Temperature Range	T_J, T_{stg}	-65 to +150	$^\circ\text{C}$

Maximum ratings are those values beyond which device damage can occur. Maximum ratings applied to the device are individual stress limit values (not normal operating conditions) and are not valid simultaneously. If these limits are exceeded, device functional operation is not implied, damage may occur and reliability may be affected.

1. FR-5 = 1.0 X 0.75 X 0.62 in.
2. Alumina = 0.4 X 0.3 X 0.024 in, 99.5% alumina.



ON Semiconductor®

<http://onsemi.com>

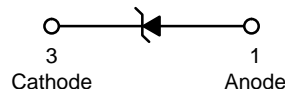

MARKING DIAGRAM

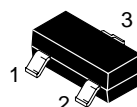

SOT-23
CASE 318
STYLE 8

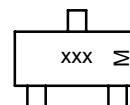

xxx = Specific Device Code
M = Date Code

ORDERING INFORMATION

Device**	Package	Shipping†
MMBZ52xxBLT1	SOT-23	3000/Tape & Reel
MMBZ52xxBLT1G	SOT-23 (Pb-Free)	3000/Tape & Reel
MMBZ52xxBLT3	SOT-23	10,000/Tape & Reel
MMBZ52xxBLT3G	SOT-23 (Pb-Free)	10,000/Tape & Reel

**The "T1" suffix refers to an 8 mm, 7 inch reel.
The "T3" suffix refers to an 8 mm, 13 inch reel.

†For information on tape and reel specifications, including part orientation and tape sizes, please refer to our Tape and Reel Packaging Specifications Brochure, BRD8011/D.

DEVICE MARKING INFORMATION

See specific marking information in the device marking column of the Electrical Characteristics table on page 3 of this data sheet.

Devices listed in **bold, italic** are ON Semiconductor **Preferred** devices. **Preferred** devices are recommended choices for future use and best overall value.

MMBZ5221BLT1 Series

ELECTRICAL CHARACTERISTICS

(Pinout: 1-Anode, 2-No Connection, 3-Cathode) ($T_A = 25^\circ\text{C}$ unless otherwise noted, $V_F = 0.95\text{ V Max. @ } I_F = 10\text{ mA}$)

Symbol	Parameter
V_Z	Reverse Zener Voltage @ I_{ZT}
I_{ZT}	Reverse Current
Z_{ZT}	Maximum Zener Impedance @ I_{ZT}
I_{ZK}	Reverse Current
Z_{ZK}	Maximum Zener Impedance @ I_{ZK}
I_R	Reverse Leakage Current @ V_R
V_R	Reverse Voltage
I_F	Forward Current
V_F	Forward Voltage @ I_F

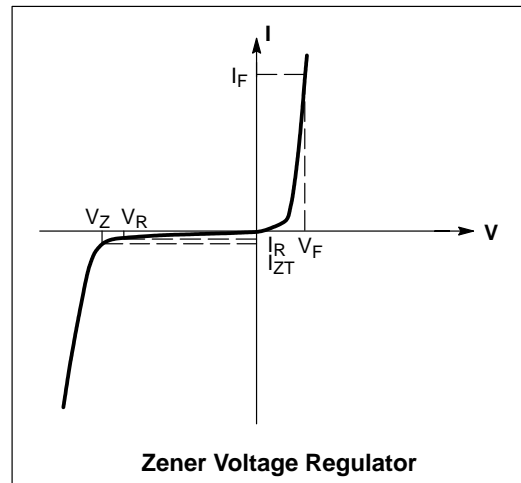

MMBZ5221BLT1 Series

ELECTRICAL CHARACTERISTICS (Pinout: 1-Anode, 2-NC, 3-Cathode) ($V_F = 0.9\text{ V Max @ } I_F = 10\text{ mA}$ for all types.)

Device	Device Marking	Zener Voltage (Note 3)			Zener Impedance			Leakage Current		
		V_Z (Volts)			@ I_{ZT}	Z_{ZT} @ I_{ZT}	Z_{ZK} @ I_{ZK}		I_R @ V_R	
		Min	Nom	Max	mA	Ω	Ω	mA	μA	Volts
MMBZ5221BL	18A	2.28	2.4	2.52	20	30	1200	0.25	100	1
MMBZ5222BL	18B	2.37	2.5	2.63	20	30	1250	0.25	100	1
MMBZ5223BL	18C	2.56	2.7	2.84	20	30	1300	0.25	75	1
MMBZ5224BL	18D	2.66	2.8	2.94	20	30	1400	0.25	75	1
MMBZ5225BL	18E	2.85	3	3.15	20	29	1600	0.25	50	1
MMBZ5226BL	8A	3.13	3.3	3.47	20	28	1600	0.25	25	1
MMBZ5227BL	8B	3.42	3.6	3.78	20	24	1700	0.25	15	1
MMBZ5228BL	8C	3.70	3.9	4.10	20	23	1900	0.25	10	1
MMBZ5229BL	8D	4.08	4.3	4.52	20	22	2000	0.25	5	1
MMBZ5230BL	8E	4.46	4.7	4.94	20	19	1900	0.25	5	2
MMBZ5231BL	8F	4.84	5.1	5.36	20	17	1600	0.25	5	2
MMBZ5232BL	8G	5.32	5.6	5.88	20	11	1600	0.25	5	3
MMBZ5233BL	8H	5.70	6	6.30	20	7	1600	0.25	5	3.5
MMBZ5234BL	8J	5.89	6.2	6.51	20	7	1000	0.25	5	4
MMBZ5235BL	8K	6.46	6.8	7.14	20	5	750	0.25	3	5
MMBZ5236BL	8L	7.12	7.5	7.88	20	6	500	0.25	3	6
MMBZ5237BL	8M	7.79	8.2	8.61	20	8	500	0.25	3	6.5
MMBZ5238BL	8N	8.26	8.7	9.14	20	8	600	0.25	3	6.5
MMBZ5239BL	8P	8.64	9.1	9.56	20	10	600	0.25	3	7
MMBZ5240BL	8Q	9.50	10	10.50	20	17	600	0.25	3	8
MMBZ5241BL	8R	10.4	11	11.55	20	22	600	0.25	2	8.4
MMBZ5242BL	8S	11.40	12	12.60	20	30	600	0.25	1	9.1
MMBZ5243BL	8T	12.35	13	13.65	9.5	13	600	0.25	0.5	9.9
MMBZ5244BL	8U	13.30	14	14.70	9	15	600	0.25	0.1	10
MMBZ5245BL	8V	14.25	15	15.75	8.5	16	600	0.25	0.1	11
MMBZ5246BL	8W	15.20	16	16.80	7.8	17	600	0.25	0.1	12
MMBZ5247BL	8X	16.15	17	17.85	7.4	19	600	0.25	0.1	13
MMBZ5248BL	8Y	17.10	18	18.90	7	21	600	0.25	0.1	14
MMBZ5249BL	8Z	18.05	19	19.95	6.6	23	600	0.25	0.1	14
MMBZ5250BL	81A	19.00	20	21.00	6.2	25	600	0.25	0.1	15
MMBZ5251BL	81B	20.90	22	23.10	5.6	29	600	0.25	0.1	17
MMBZ5252BL	81C	22.80	24	25.20	5.2	33	600	0.25	0.1	18
MMBZ5253BL	81D	23.75	25	26.25	5	35	600	0.25	0.1	19
MMBZ5254BL	81E	25.65	27	28.35	4.6	41	600	0.25	0.1	21
MMBZ5255BL	81F	26.60	28	29.40	4.5	44	600	0.25	0.1	21
MMBZ5256BL	81G	28.50	30	31.50	4.2	49	600	0.25	0.1	23
MMBZ5257BL	81H	31.35	33	34.65	3.8	58	700	0.25	0.1	25
MMBZ5258BL	81J	34.20	36	37.80	3.4	70	700	0.25	0.1	27
MMBZ5259BL	81K	37.05	39	40.95	3.2	80	800	0.25	0.1	30
MMBZ5260BL	81L	40.85	43	45.15	3	93	900	0.25	0.1	33
MMBZ5261BL	81M	44.65	47	49.35	2.7	105	1000	0.25	0.1	36
MMBZ5262BL	81N	48.45	51	53.55	2.5	125	1100	0.25	0.1	39
MMBZ5263BL	81P	53.20	56	58.80	2.2	150	1300	0.25	0.1	43
MMBZ5264BL	81Q	57.00	60	63.00	2.1	170	1400	0.25	0.1	46
MMBZ5265BL	81R	58.90	62	65.10	2	185	1400	0.25	0.1	47
MMBZ5266BL	81S	64.60	68	71.40	1.8	230	1600	0.25	0.1	52
MMBZ5267BL	81T	71.25	75	78.75	1.7	270	1700	0.25	0.1	56
MMBZ5268BL	81U	77.90	82	86.10	1.5	330	2000	0.25	0.1	62
MMBZ5269BL	81V	82.65	87	91.35	1.4	370	2200	0.25	0.1	68
MMBZ5270BL	81W	86.45	91	95.55	1.4	400	2300	0.25	0.1	69

3. Zener voltage is measured with a pulse test current I_Z at an ambient temperature of 25°C

NOTE: MMBZ5233BLT1, MMBZ5246BLT1, MMBZ5251BLT1, and MMBZ5252BLT1 Not Available in 10,000/Tape & Reel.

MMBZ5221BLT1 Series

TYPICAL CHARACTERISTICS

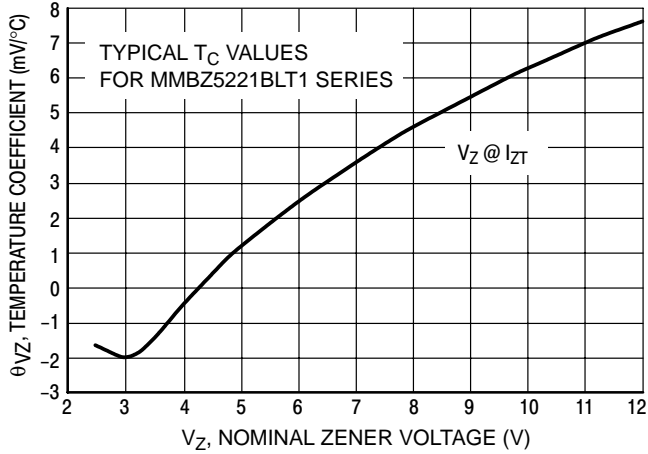

Figure 1. Temperature Coefficients
(Temperature Range -55°C to +150°C)

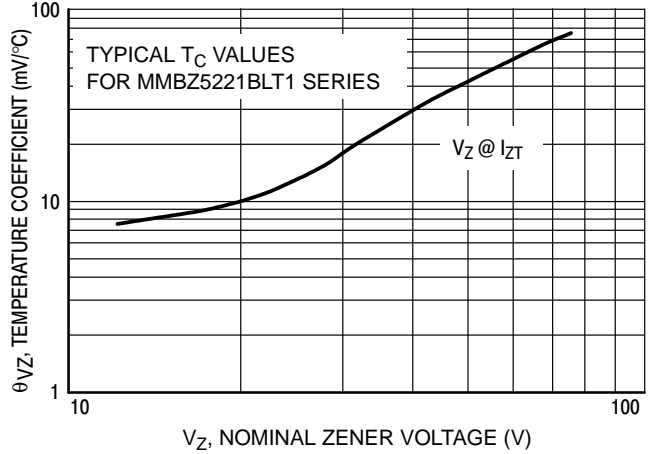

Figure 2. Temperature Coefficients
(Temperature Range -55°C to +150°C)

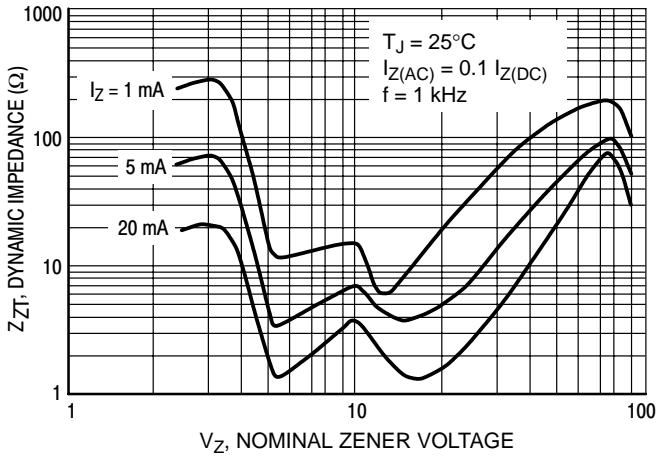

Figure 3. Effect of Zener Voltage on Zener Impedance

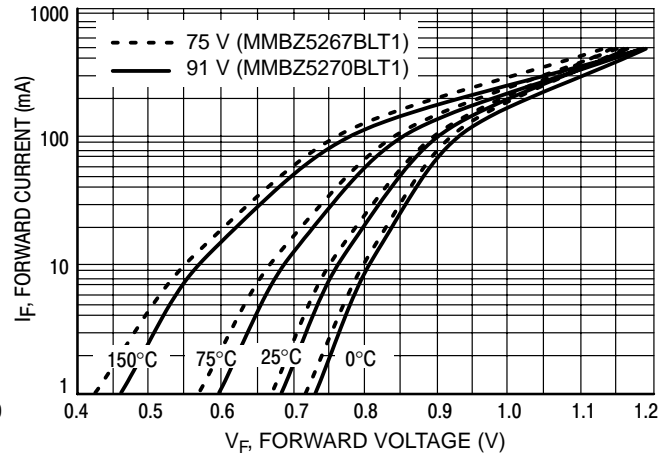

Figure 4. Typical Forward Voltage

MMBZ5221BLT1 Series

TYPICAL CHARACTERISTICS

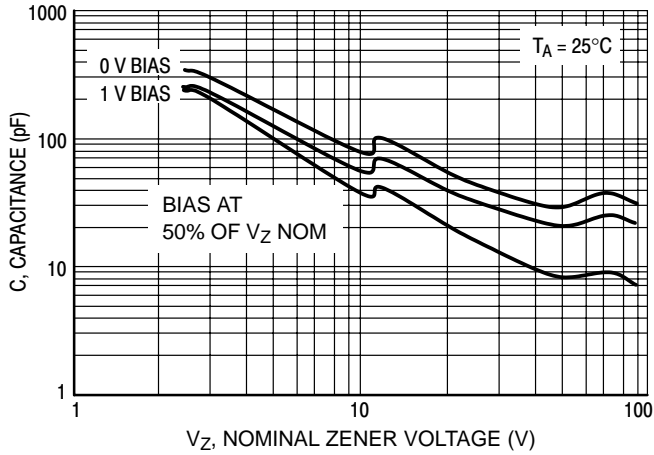

Figure 5. Typical Capacitance

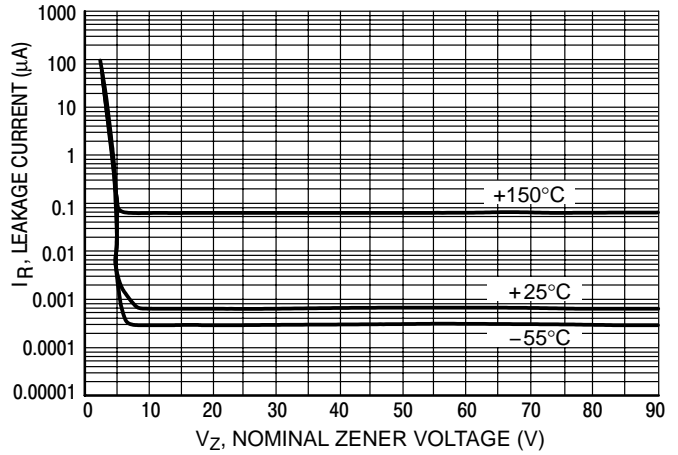

Figure 6. Typical Leakage Current

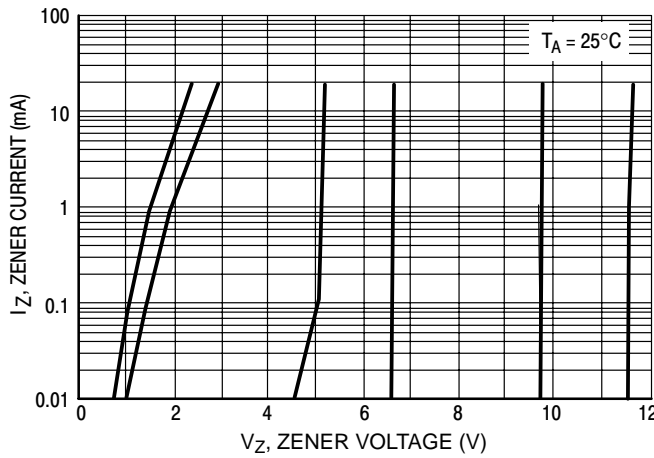

Figure 7. Zener Voltage versus Zener Current (V_Z Up to 12 V)

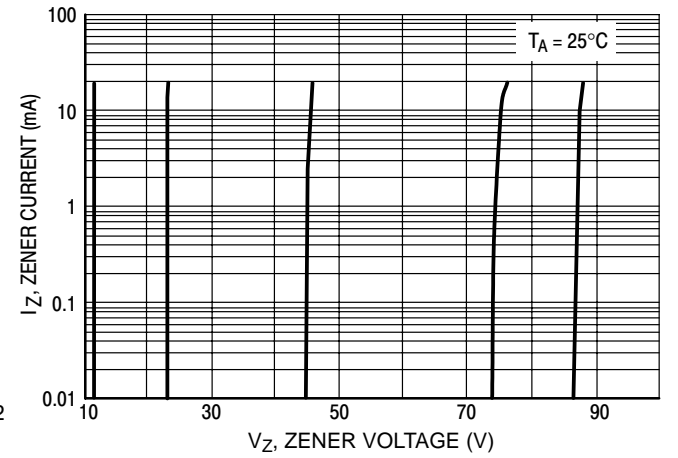
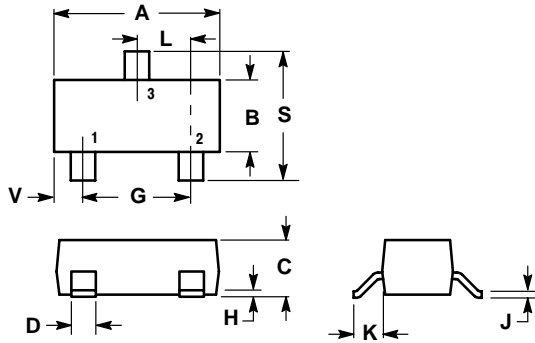

Figure 8. Zener Voltage versus Zener Current (12 V to 91 V)

MMB5221BLT1 Series

PACKAGE DIMENSIONS

SOT-23 (TO-236)
CASE 318-08
ISSUE AJ



NOTES:

1. DIMENSIONING AND TOLERANCING PER ANSI Y14.5M, 1982.
2. CONTROLLING DIMENSION: INCH.
3. MAXIMUM LEAD THICKNESS INCLUDES LEAD FINISH THICKNESS. MINIMUM LEAD THICKNESS IS THE MINIMUM THICKNESS OF BASE MATERIAL.
4. 318-03 AND -07 OBSOLETE, NEW STANDARD 318-08.

DIM	INCHES		MILLIMETERS	
	MIN	MAX	MIN	MAX
A	0.1102	0.1197	2.80	3.04
B	0.0472	0.0551	1.20	1.40
C	0.0350	0.0440	0.89	1.11
D	0.0150	0.0200	0.37	0.50
G	0.0701	0.0807	1.78	2.04
H	0.0005	0.0040	0.013	0.100
J	0.0034	0.0070	0.085	0.177
K	0.0140	0.0285	0.35	0.69
L	0.0350	0.0401	0.89	1.02
S	0.0830	0.1039	2.10	2.64
V	0.0177	0.0236	0.45	0.60

STYLE 8:

1. ANODE
2. NO CONNECTION
3. CATHODE

SOLDERING FOOTPRINT*

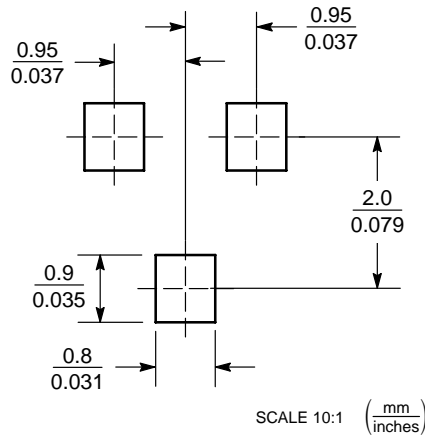

*For additional information on our Pb-Free strategy and soldering details, please download the ON Semiconductor Soldering and Mounting Techniques Reference Manual, SOLDERRM/D.

ON Semiconductor and are registered trademarks of Semiconductor Components Industries, LLC (SCILLC). SCILLC reserves the right to make changes without further notice to any products herein. SCILLC makes no warranty, representation or guarantee regarding the suitability of its products for any particular purpose, nor does SCILLC assume any liability arising out of the application or use of any product or circuit, and specifically disclaims any and all liability, including without limitation special, consequential or incidental damages. "Typical" parameters which may be provided in SCILLC data sheets and/or specifications can and do vary in different applications and actual performance may vary over time. All operating parameters, including "Typicals" must be validated for each customer application by customer's technical experts. SCILLC does not convey any license under its patent rights nor the rights of others. SCILLC products are not designed, intended, or authorized for use as components in systems intended for surgical implant into the body, or other applications intended to support or sustain life, or for any other application in which the failure of the SCILLC product could create a situation where personal injury or death may occur. Should Buyer purchase or use SCILLC products for any such unintended or unauthorized application, Buyer shall indemnify and hold SCILLC and its officers, employees, subsidiaries, affiliates, and distributors harmless against all claims, costs, damages, and expenses, and reasonable attorney fees arising out of, directly or indirectly, any claim of personal injury or death associated with such unintended or unauthorized use, even if such claim alleges that SCILLC was negligent regarding the design or manufacture of the part. SCILLC is an Equal Opportunity/Affirmative Action Employer. This literature is subject to all applicable copyright laws and is not for resale in any manner.

PUBLICATION ORDERING INFORMATION

LITERATURE FULFILLMENT:
Literature Distribution Center for ON Semiconductor
P.O. Box 61312, Phoenix, Arizona 85082-1312 USA
Phone: 480-829-7710 or 800-344-3860 Toll Free USA/Canada
Fax: 480-829-7709 or 800-344-3867 Toll Free USA/Canada
Email: orderlit@onsemi.com

N. American Technical Support: 800-282-9855 Toll Free
USA/Canada

Japan: ON Semiconductor, Japan Customer Focus Center
2-9-1 Kamimeguro, Meguro-ku, Tokyo, Japan 153-0051
Phone: 81-3-5773-3850

ON Semiconductor Website: <http://onsemi.com>

Order Literature: <http://www.onsemi.com/litorder>

For additional information, please contact your local Sales Representative.