

# E.S.D NOISE CLIPPING DIODES NNCD3.3F to NNCD12F

## ELECTROSTATIC DISCHARGE NOISE CLIPPING DIODES (DOUBLE TYPE, ANODE COMMON) 3PIN MINI MOLD

This product series is a diode developed for E.S.D (Electrostatic Discharge) noise protection. Based on the IEC1000-4-2 test on electromagnetic interference (EMI), the diode assures an endurance of no less than 30 kV, thus making itself most suitable for external interface circuit protection.

Type NNCD3.3F to NNCD12F Series include two elements in 3PIN Mini Mold Package having allowable power dissipation of 200 mW.

### FEATURES

- Based on the electrostatic discharge immunity test (IEC1000-4-2), the product assures the minimum endurance of 30 kV.
- Based on the reference supply of the set, the product achieves a series over a wide range (15 product name lined up).

### APPLICATIONS

- External interface circuit E.S.D protection.
- Circuits for Waveform clipper, Surge absorber.

### MAXIMUM RATINGS (T<sub>A</sub> = 25 °C)

Power Dissipation	P	200 mW	(Total)
Surge Reverse Power	P <sub>RSM</sub>	100 W (t <sub>T</sub> = 10 μs 1 pulse)	Fig. 6
Junction Temperature	T <sub>j</sub>	150 °C	
Storage Temperature	T <sub>stg</sub>	-55 °C to +150 °C	

### PACKAGE DIMENSIONS (in millimeters)

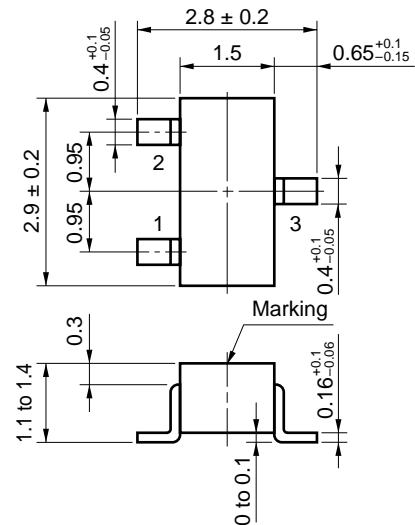

### PIN CONNECTION

1. K1: Cathode 1 SC-59 (EIAJ)
2. K2: Cathode 2
3. A : Anode (common)

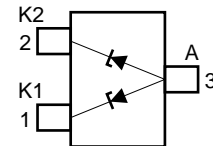

ELECTRICAL CHARACTERISTICS (T<sub>A</sub> = 25 °C) (A-K1, A-K2)

Type Number	Breakdown Voltage <sup>Note 1</sup> V <sub>BR</sub> (V)			Dynamic Impedance <sup>Note 2</sup> Z <sub>z</sub> (Ω)		Reverse Leakage I <sub>R</sub> (μA)		Capacitance C <sub>t</sub> (pF)		E.S.D Voltage (kV)	
	MIN.	MAX.	I <sub>T</sub> (mA)	MAX.	I <sub>T</sub> (mA)	MAX.	V <sub>R</sub> (V)	TYP.	TEST CONDITION	MIN.	TEST CONDITION
NNCD3.3F	3.10	3.50	5	130	5	20	1.0	220	V <sub>R</sub> = 0 V f = 1 MHz	30	C = 150 pF R = 330 Ω (IEC1000-4-2)
NNCD3.6F	3.40	3.80	5	130	5	10	1.0	210		30	
NNCD3.9F	3.70	4.10	5	130	5	10	1.0	200		30	
NNCD4.3F	4.01	4.48	5	130	5	10	1.0	180		30	
NNCD4.7F	4.42	4.90	5	130	5	10	1.0	170		30	
NNCD5.1F	4.84	5.37	5	130	5	5	1.5	160		30	
NNCD5.6F	5.31	5.92	5	80	5	5	2.5	140		30	
NNCD6.2F	5.86	6.53	5	50	5	2	3.0	120		30	
NNCD6.8F	6.47	7.14	5	30	5	2	3.5	110		30	
NNCD7.5F	7.06	7.84	5	30	5	2	4.0	90		30	
NNCD8.2F	7.76	8.64	5	30	5	2	5.0	90		30	
NNCD9.1F	8.56	9.55	5	30	5	2	6.0	90		30	
NNCD10F	9.45	10.55	5	30	5	2	7.0	80		30	
NNCD11F	10.44	11.56	5	30	5	2	8.0	70	30		
NNCD12F	11.42	12.60	5	35	5	2	9.0	70	30		

- Notes** 1. Tested with pulse (40 ms)  
 2. Z<sub>z</sub> is measured at I<sub>T</sub> give a small A.C. signal.

TYPICAL CHARACTERISTICS (T<sub>A</sub> = 25 °C)

Fig. 1 POWER DISSIPATION vs. AMBIENT TEMPERATURE

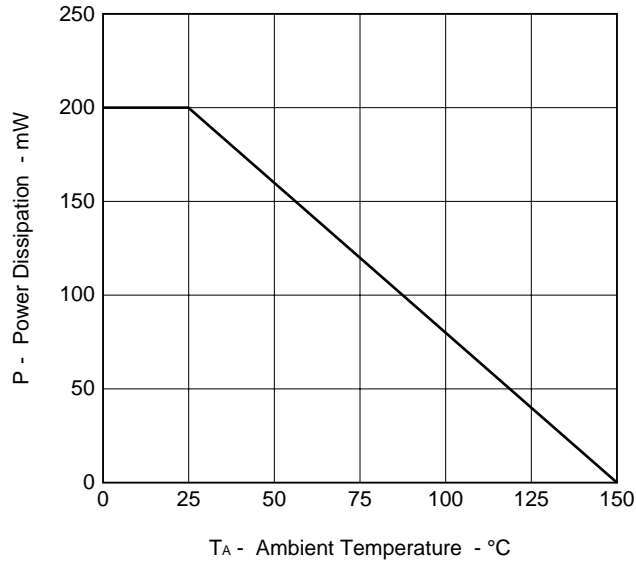

Fig. 2 I<sub>T</sub> - V<sub>BR</sub> CHARACTERISTICS

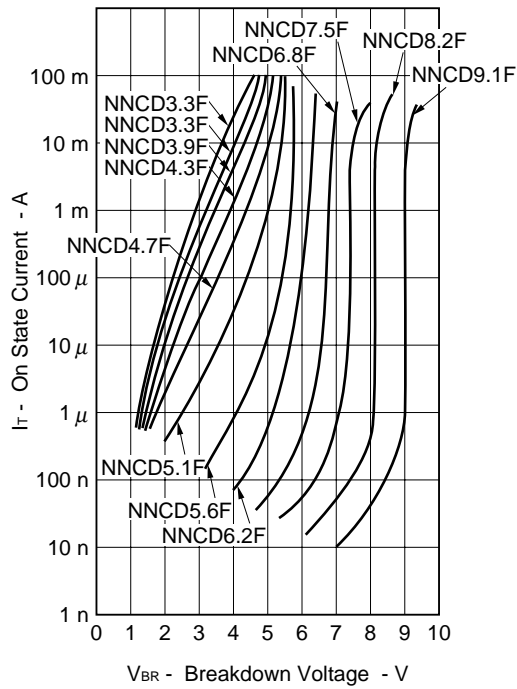

Fig. 3 I<sub>T</sub> - V<sub>BR</sub> CHARACTERISTICS

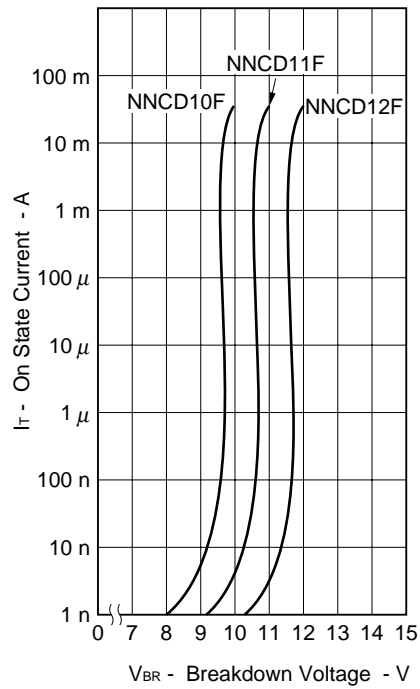

Fig. 4 Z<sub>z</sub> - I<sub>T</sub> CHARACTERISTICS

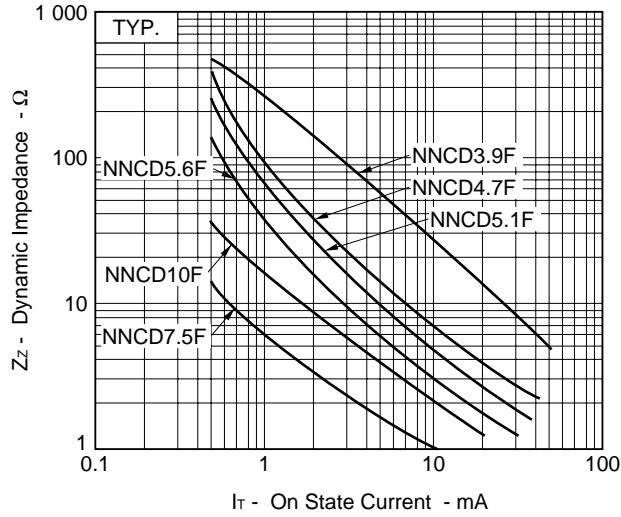

Fig. 5 TRANSIENT THERMAL IMPEDANCE

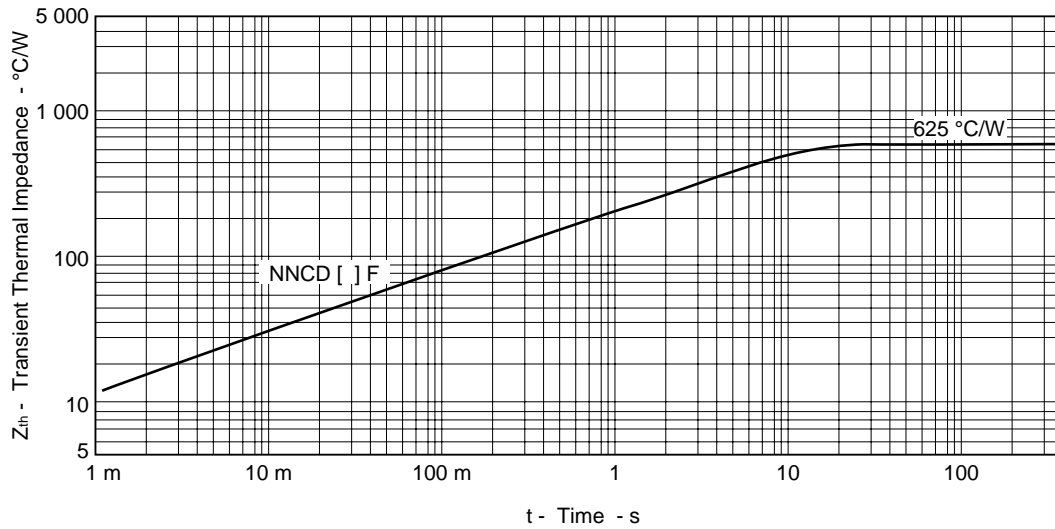
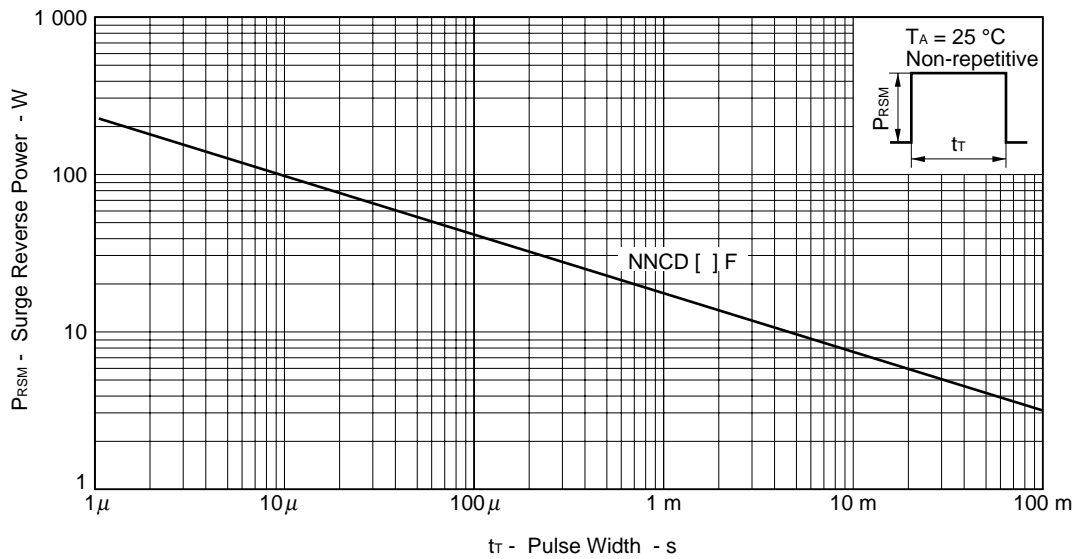
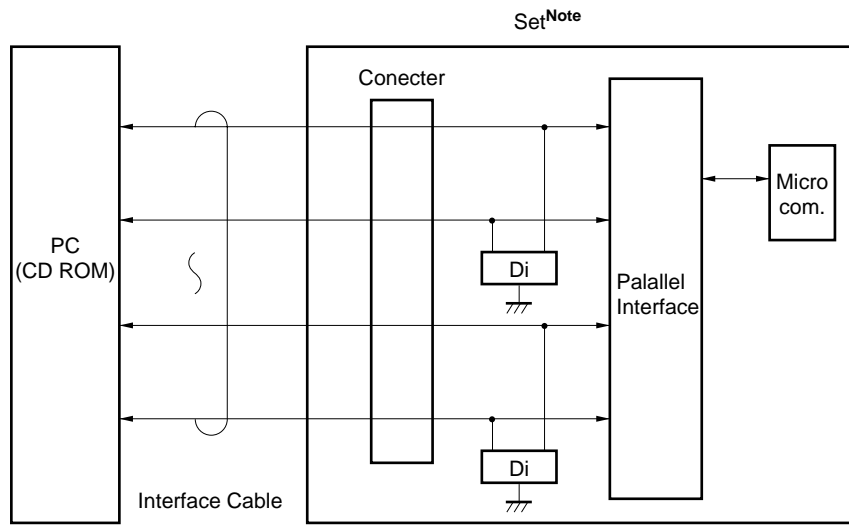

Fig. 6 SURGE REVERSE POWER RATING



Sample Application Circuits



**Note** Set  
Printer, P.D.C, T.V Game etc.

**REFERENCE**

Document Name	Document No.
NEC semiconductor device reliability/quality control system	C11745E
NEC semiconductor device reliability/quality control system	MEI-1201
Quality grade on NEC semiconductor device	C11531E
Semiconductor device mounting technology manual	C10535E
Guide to quality assurance for semiconductor device	MEI-1202

[MEMO]

[MEMO]

No part of this document may be copied or reproduced in any form or by any means without the prior written consent of NEC Corporation. NEC Corporation assumes no responsibility for any errors which may appear in this document.

NEC Corporation does not assume any liability for infringement of patents, copyrights or other intellectual property rights of third parties by or arising from use of a device described herein or any other liability arising from use of such device. No license, either express, implied or otherwise, is granted under any patents, copyrights or other intellectual property rights of NEC Corporation or others.

While NEC Corporation has been making continuous effort to enhance the reliability of its semiconductor devices, the possibility of defects cannot be eliminated entirely. To minimize risks of damage or injury to persons or property arising from a defect in an NEC semiconductor device, customers must incorporate sufficient safety measures in its design, such as redundancy, fire-containment, and anti-failure features.

NEC devices are classified into the following three quality grades:

"Standard", "Special", and "Specific". The Specific quality grade applies only to devices developed based on a customer designated "quality assurance program" for a specific application. The recommended applications of a device depend on its quality grade, as indicated below. Customers must check the quality grade of each device before using it in a particular application.

Standard: Computers, office equipment, communications equipment, test and measurement equipment, audio and visual equipment, home electronic appliances, machine tools, personal electronic equipment and industrial robots

Special: Transportation equipment (automobiles, trains, ships, etc.), traffic control systems, anti-disaster systems, anti-crime systems, safety equipment and medical equipment (not specifically designed for life support)

Specific: Aircrafts, aerospace equipment, submersible repeaters, nuclear reactor control systems, life support systems or medical equipment for life support, etc.

The quality grade of NEC devices is "Standard" unless otherwise specified in NEC's Data Sheets or Data Books. If customers intend to use NEC devices for applications other than those specified for Standard quality grade, they should contact an NEC sales representative in advance.

Anti-radioactive design is not implemented in this product.