

The RF Line  
**NPN Silicon**  
**Low Noise, High-Frequency**  
**Transistors**

Designed for use in high gain, low noise small-signal amplifiers. This series features excellent broadband linearity and is offered in a variety of packages.

- Fully Implanted Base and Emitter Structure
- 9 Finger, 1.25 Micron Geometry with Gold Top Metal
- Gold Sintered Back Metal
- Available in tape and reel packaging options:
  - T1 suffix = 3,000 units per reel
  - T3 suffix = 10,000 units per reel

**MMBR941**  
**MRF947**  
**SERIES**

$I_C = 50 \text{ mA}$   
LOW NOISE  
HIGH-FREQUENCY  
TRANSISTORS

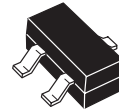

CASE 318-08, STYLE 6  
SOT-23  
LOW PROFILE  
MMBR941LT1, T3, MMBR941BLT1

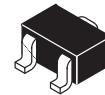

CASE 419-02, STYLE 3  
MRF947AT1, MRF947BT1,  
MRF947T1, T3

LIFETIME BUY

LAST SHIP: 26MAR02  
LAST ORDER: 25SEP01



**MAXIMUM RATINGS**

Rating	Symbol	MMBR941LT1, T3	MRF947 Series	Unit
Collector–Emitter Voltage	$V_{CEO}$	10	10	Vdc
Collector–Base Voltage	$V_{CBO}$	20	20	Vdc
Emitter–Base Voltage	$V_{EBO}$	1.5	1.5	Vdc
Power Dissipation (1) $T_C = 75^\circ\text{C}$ Derate linearly above $T_{\text{case}} = 75^\circ\text{C}$ @	$P_{D\text{max}}$	0.25 3.33	0.188 2.5	Watts mW/ $^\circ\text{C}$
Collector Current — Continuous (2)	$I_C$	50	50	mA
Maximum Junction Temperature	$T_{J\text{max}}$	150	150	$^\circ\text{C}$
Storage Temperature	$T_{\text{stg}}$	–55 to +150	–55 to +150	$^\circ\text{C}$
Thermal Resistance, Junction to Case	$R_{\theta\text{JC}}$	300	400	$^\circ\text{C}/\text{W}$

**DEVICE MARKING**

MMBR941LT1 = 7Y MRF947AT1 = G	MMBR941BLT1 = 7N	MRF947T1, T3 = A	MRF947BT1 = H
----------------------------------	------------------	------------------	---------------

**ELECTRICAL CHARACTERISTICS** ( $T_A = 25^\circ\text{C}$  unless otherwise noted)

Characteristic	Symbol	Min	Typ	Max	Unit
----------------	--------	-----	-----	-----	------

**OFF CHARACTERISTICS (3)**

Collector–Emitter Breakdown Voltage ( $I_C = 0.1\text{ mA}$ , $I_B = 0$ )	All	$V_{(\text{BR})\text{CEO}}$	10	12	—	Vdc
Collector–Base Breakdown Voltage ( $I_C = 0.1\text{ mA}$ , $I_E = 0$ )	All	$V_{(\text{BR})\text{CBO}}$	20	23	—	Vdc
Emitter Cutoff Current ( $V_{EB} = 1.0\text{ V}$ , $I_C = 0$ )	All	$I_{EBO}$	—	—	0.1	$\mu\text{Adc}$
Collector Cutoff Current ( $V_{CB} = 10\text{ V}$ , $I_E = 0$ )	All	$I_{CBO}$	—	—	0.1	$\mu\text{Adc}$

**ON CHARACTERISTICS (3)**

DC Current Gain ( $V_{CE} = 6.0\text{ V}$ , $I_C = 5.0\text{ mA}$ ) (MMBR941LT1) (MMBR941BLT1)		$h_{FE}$	50 100	— —	200 200	—
DC Current Gain ( $V_{CE} = 1.0\text{ V}$ , $I_C = 500\text{ }\mu\text{A}$ )	MRF947T1, MRF947BT1	$h_{FE1}$	50	—	—	—
DC Current Gain ( $V_{CE} = 6.0\text{ V}$ , $I_C = 5.0\text{ mA}$ )	MRF947T1, T3 MRF947AT1 MRF947BT1	$h_{FE2}$ $h_{FE3}$ $h_{FE4}$	50 75 100	— — —	— 150 200	—

**DYNAMIC CHARACTERISTICS**

Collector–Base Capacitance ( $V_{CB} = 10\text{ V}$ , $I_E = 0$ , $f = 1.0\text{ MHz}$ )	All	$C_{cb}$	—	0.35	—	pF
Current Gain — Bandwidth Product ( $V_{CE} = 6.0\text{ V}$ , $I_C = 15\text{ mA}$ , $f = 1.0\text{ GHz}$ )	All	$f_T$	—	8.0	—	GHz

**NOTE:**

- To calculate the junction temperature use  $T_J = P_D \times R_{\theta\text{JC}} + T_{\text{CASE}}$ . Case temperature measured on collector lead immediately adjacent to body of package.
- $I_C$  — Continuous (MTBF  $\approx 10$  years).
- Pulse width  $\leq 300\text{ }\mu\text{s}$ , duty cycle  $\leq 2\%$  pulsed.

**PERFORMANCE CHARACTERISTICS**

Conditions	Symbol	MMBR941LT1, T3			MRF947 Series			Unit
		Min	Typ	Max	Min	Typ	Max	
Insertion Gain ( $V_{CE} = 6.0\text{ V}$ , $I_C = 15\text{ mA}$ , $f = 1.0\text{ GHz}$ ) ( $V_{CE} = 6.0\text{ V}$ , $I_C = 15\text{ mA}$ , $f = 2.0\text{ GHz}$ )	$ S_{21} ^2$	—	14 8.0	—	—	14 10.8	—	dB
Maximum Unilateral Gain (1) ( $V_{CE} = 6.0\text{ V}$ , $I_C = 15\text{ mA}$ , $f = 1.0\text{ GHz}$ ) ( $V_{CE} = 6.0\text{ V}$ , $I_C = 15\text{ mA}$ , $f = 2.0\text{ GHz}$ )	$G_{U\text{ max}}$	—	16 10	—	—	14.8 11.6	—	dB
Noise Figure — Minimum (Figure 9) ( $V_{CE} = 6.0\text{ V}$ , $I_C = 5.0\text{ mA}$ , $f = 1.0\text{ GHz}$ ) ( $V_{CE} = 6.0\text{ V}$ , $I_C = 5.0\text{ mA}$ , $f = 2.0\text{ GHz}$ )	$NF_{\text{MIN}}$	—	1.5 2.1	—	—	1.5 2.1	—	dB
Associated Gain at Minimum NF (Figure 9) ( $V_{CE} = 6.0\text{ V}$ , $I_C = 5.0\text{ mA}$ , $f = 1.0\text{ GHz}$ ) ( $V_{CE} = 6.0\text{ V}$ , $I_C = 5.0\text{ mA}$ , $f = 2.0\text{ GHz}$ )	$G_{\text{NF}}$	—	14 8.5	—	—	14 10	—	dB
Noise Figure — 50 ohm Source ( $V_{CE} = 6.0\text{ V}$ , $I_C = 5.0\text{ mA}$ , $f = 1.0\text{ GHz}$ )	$NF_{50\ \Omega}$	—	1.9	2.8	—	1.9	2.8	dB

NOTE:

1. Maximum Unilateral Gain is  $G_{U\text{ max}} = \frac{|S_{21}|^2}{(1-|S_{11}|^2)(1-|S_{22}|^2)}$

**TYPICAL CHARACTERISTICS**  
**MMBR941LT1, T3; MMBR941BLT1**

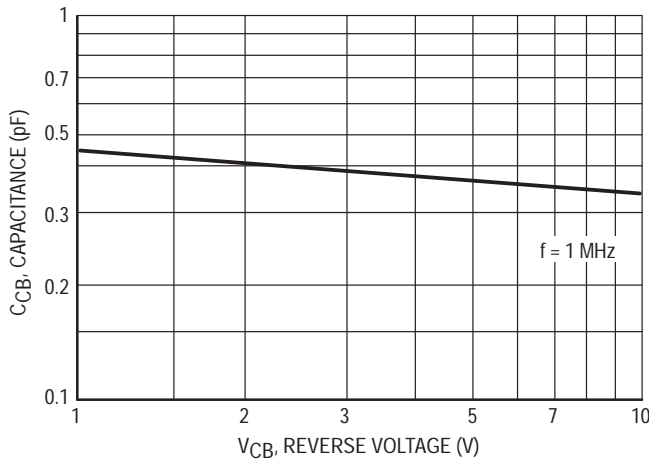

**Figure 1. Collector-Base Capacitance versus Voltage**

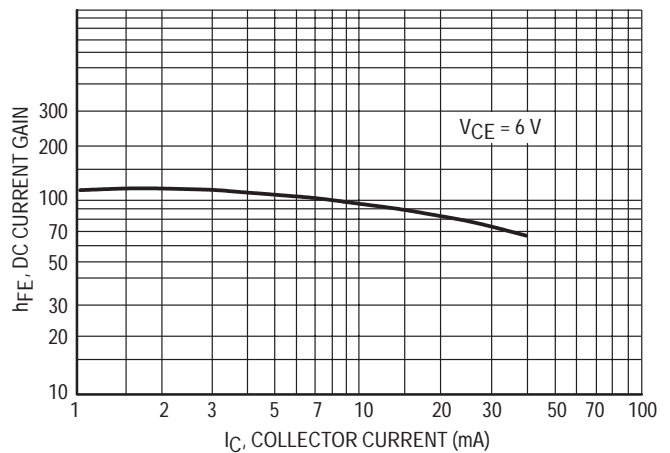

**Figure 2. DC Current Gain versus Collector Current**

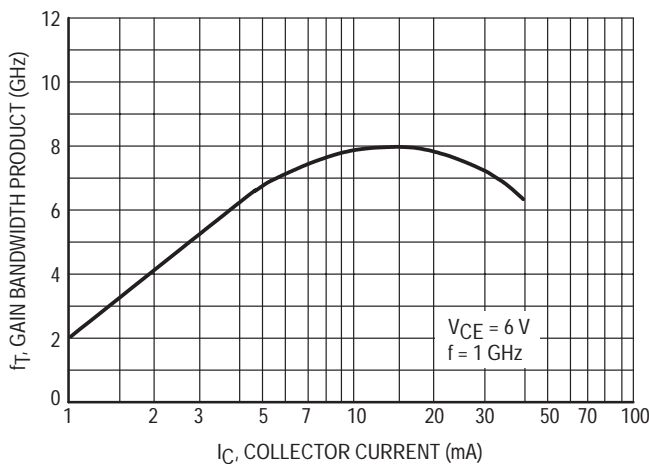

**Figure 3. Gain Bandwidth Product versus Collector Current**

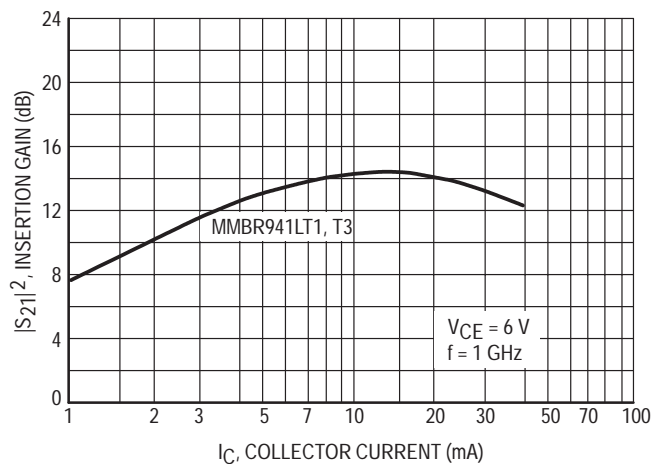

**Figure 4. Insertion Gain versus Collector Current**

LIFETIME BUY

LAST SHIP: 26MAR02  
LAST ORDER: 25SEP01

**FORWARD INSERTION GAIN AND  
MAXIMUM UNILATERAL GAIN versus FREQUENCY**

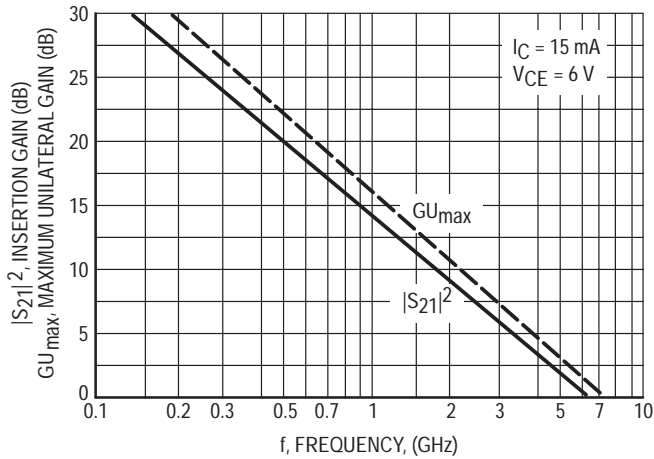

Figure 5. MMBR941LT1, T3

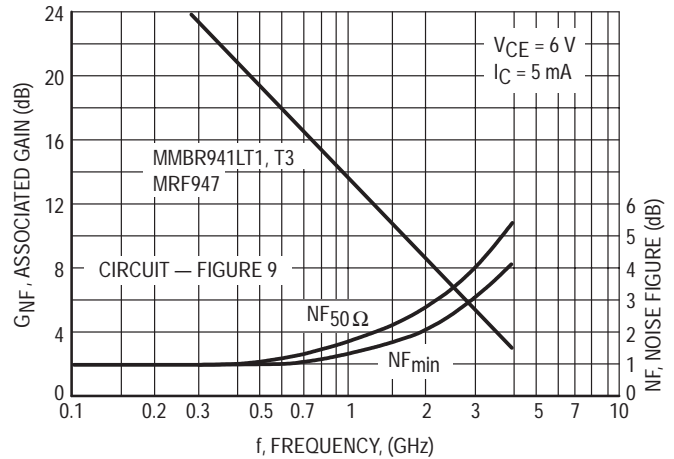

Figure 6. Noise Figure and Associated Gain versus Frequency

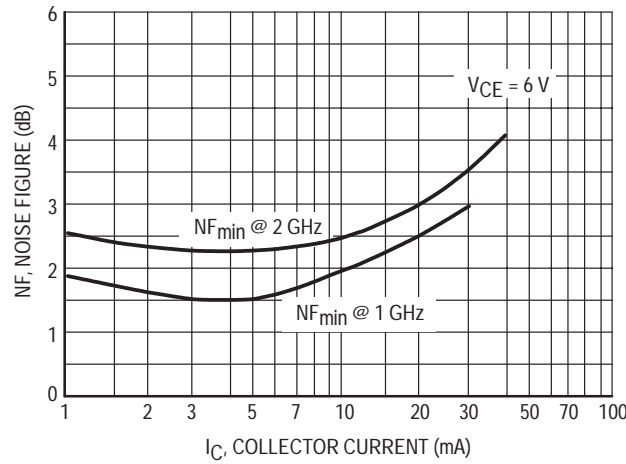

Figure 7. Minimum Noise Figure versus Collector Current

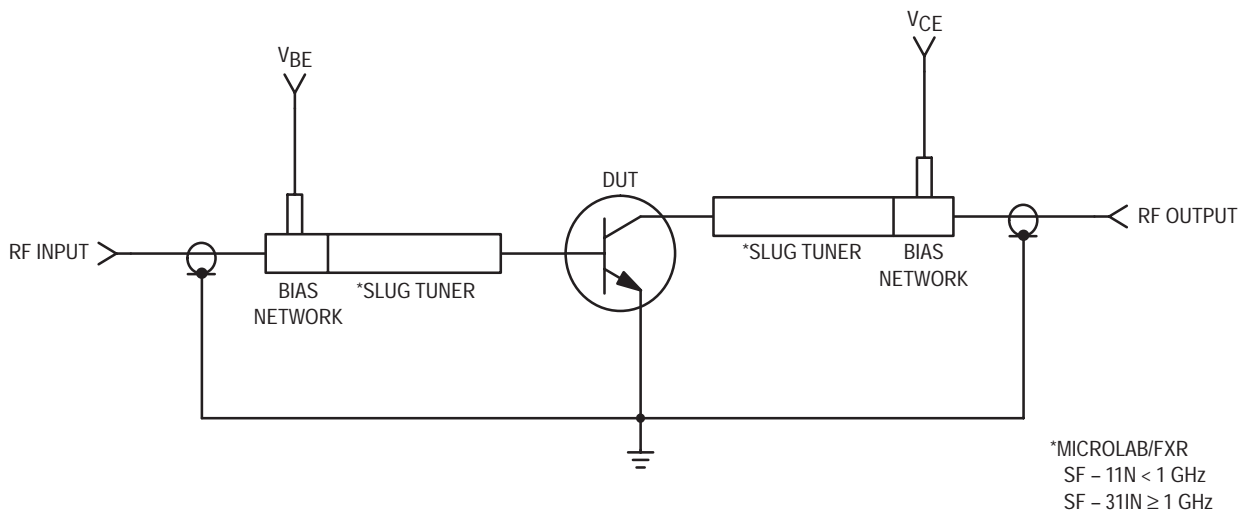

Figure 8. Functional Circuit Schematic (all devices)

TYPICAL CHARACTERISTICS  
MRF947 SERIES

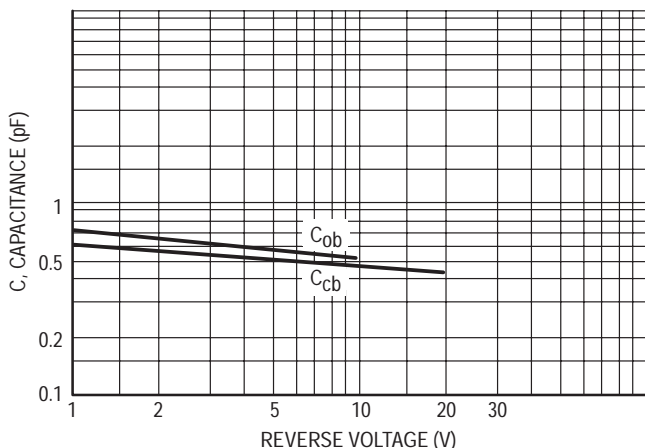

Figure 9. Capacitance versus Voltage

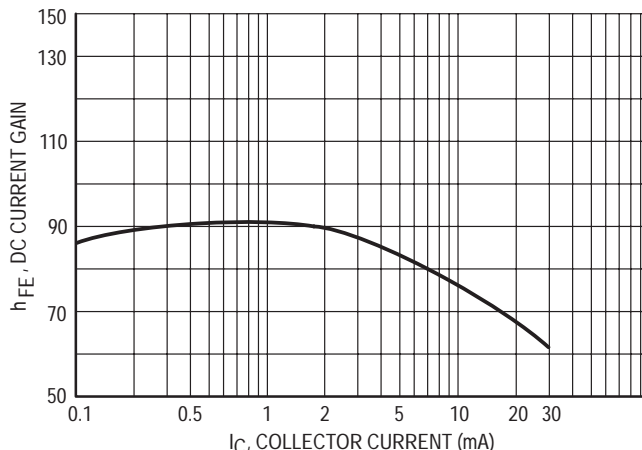

Figure 10. DC Current Gain versus Collector Current

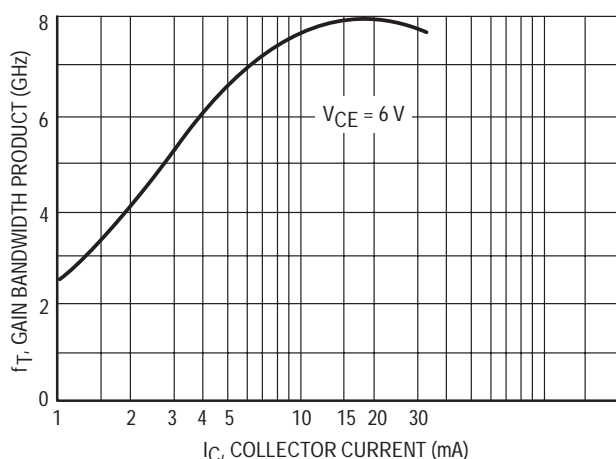

Figure 11. Gain-Bandwidth Product versus Collector Current

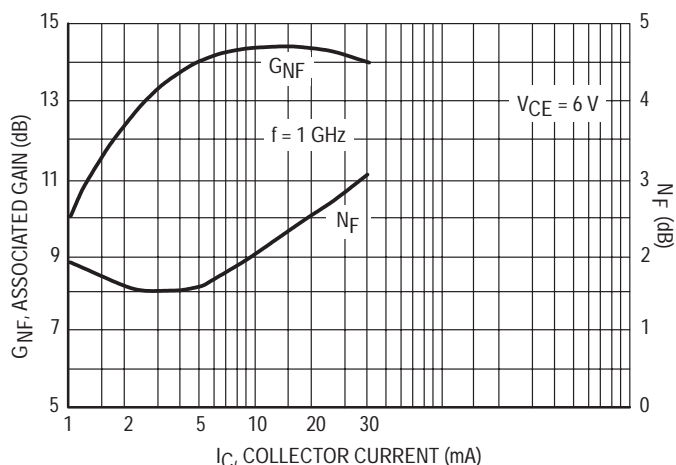

Figure 12. Associated Gain and Minimum Noise Figure versus Collector Current

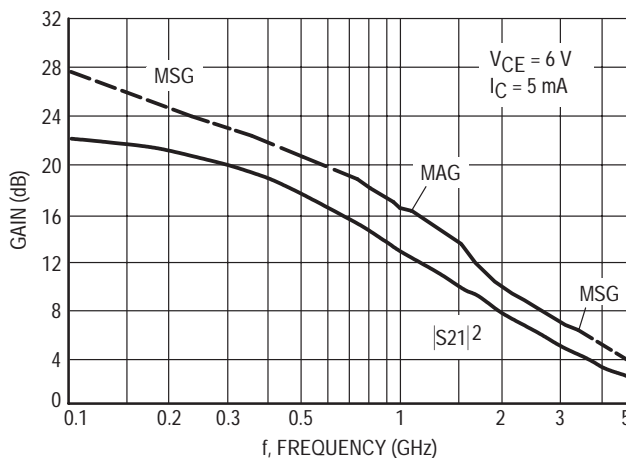

Figure 13. Forward Insertion Gain and Maximum Stable/Available Power Gain versus Frequency

LIFETIME BUY

LAST ORDER: 25SEP01 LAST SHIP: 26MAR02

V <sub>CE</sub> (Volts)	I <sub>C</sub> (mA)	f (MHz)	S <sub>11</sub>		S <sub>21</sub>		S <sub>12</sub>		S <sub>22</sub>		
			Mag	∠φ	Mag	∠φ	Mag	∠φ	Mag	∠φ	
1.0	0.5	100	0.97	-11	1.78	170	0.03	83	0.99	-4.7	
		200	0.96	-22	1.74	161	0.06	76	0.99	-9.1	
		500	0.90	-53	1.60	133	0.13	56	0.93	-21	
		900	0.75	-89	1.37	105	0.18	37	0.83	-33	
		1000	0.72	-98	1.32	100	0.18	33	0.82	-36	
		1500	0.63	-132	1.07	74	0.19	20	0.75	-47	
		2000	0.57	-163	0.89	55	0.16	15	0.72	-57	
		3000	0.55	144	0.67	30	0.15	40	0.71	-76	
		1.0	100	0.95	-13	3.37	169	0.03	81	0.99	-6.2
	200	0.93	-27	3.27	158	0.06	73	0.98	-12		
	500	0.81	-62	2.85	128	0.12	52	0.86	-26		
	900	0.63	-101	2.21	101	0.15	37	0.73	-38		
	1000	0.60	-110	2.08	96	0.15	34	0.71	-40		
	1500	0.51	-144	1.59	73	0.16	27	0.64	-49		
	2000	0.46	-173	1.28	56	0.16	29	0.61	-58		
	3000	0.46	138	0.95	30	0.19	44	0.60	-75		
	6.0	5.0	100	0.82	-25	14.6	159	0.02	77	0.94	-13
			200	0.75	-47	12.6	142	0.04	68	0.85	-22
400			0.55	-79	9.2	120	0.05	61	0.69	-31	
600			0.42	-98	6.9	106	0.07	60	0.60	-32	
800			0.33	-114	5.3	97	0.08	61	0.56	-33	
1000			0.28	-129	4.5	90	0.09	62	0.52	-33	
1500			0.25	-155	3.1	77	0.13	67	0.51	-37	
2000			0.16	176	2.4	66	0.16	68	0.51	-36	
2500			0.21	151	2.0	57	0.20	69	0.48	-40	
3000			0.18	122	1.7	50	0.23	68	0.48	-44	
3500			0.30	108	1.5	42	0.27	66	0.45	-46	
4000			0.29	91	1.4	37	0.32	64	0.42	-53	
10			100	0.67	-37	23.5	149	0.02	74	0.88	-18
200			0.54	-64	18.1	129	0.03	68	0.73	-28	
400			0.37	-96	11.3	108	0.05	67	0.56	-31	
600			0.26	-114	8.0	98	0.06	67	0.50	-30	
800			0.21	-130	6.0	91	0.08	70	0.47	-30	
1000			0.18	-147	5.1	85	0.09	70	0.45	-30	
1500		0.18	-167	3.4	74	0.13	72	0.46	-34		
2000		0.11	159	2.6	64	0.17	71	0.46	-34		
2500		0.17	140	2.2	56	0.21	69	0.44	-38		
3000		0.15	107	1.8	59	0.25	67	0.45	-41		
3500		0.27	100	1.7	42	0.28	65	0.42	-42		
4000		0.26	85	1.5	37	0.33	61	0.39	-49		
15		100	0.56	-46	28.6	143	0.02	73	0.83	-22	
200		0.43	-75	20.2	122	0.03	67	0.65	-30		
400		0.29	-107	11.8	104	0.04	70	0.50	-30		
600		0.22	-125	8.2	95	0.06	74	0.46	-28		
800		0.18	-141	6.2	88	0.08	74	0.45	-27		
1000		0.16	-158	5.1	83	0.09	74	0.43	-28		
1500		0.17	-174	3.4	72	0.13	73	0.44	-32		
2000		0.11	150	2.6	63	0.17	72	0.45	-33		
2500		0.17	138	2.2	55	0.21	70	0.43	-37		
3000		0.15	102	1.9	49	0.25	67	0.44	-39		
3500		0.28	98	1.7	42	0.29	65	0.40	-41		
4000		0.25	82	1.5	37	0.32	61	0.38	-47		

Table 1. MMBR941LT1, T3 Common Emitter S-Parameters

VCE (Volts)	I <sub>C</sub> (mA)	f (MHz)	S <sub>11</sub>		S <sub>21</sub>		S <sub>12</sub>		S <sub>22</sub>	
			Mag	∠φ	Mag	∠φ	Mag	∠φ	Mag	∠φ
6.0	20	100	0.49	-52	31.5	139	0.01	70	0.79	-23
		200	0.36	-84	21.1	118	0.02	69	0.60	-29
		400	0.25	-115	12.1	101	0.04	73	0.48	-29
		600	0.20	-134	8.3	93	0.06	74	0.45	-26
		800	0.16	-150	6.2	87	0.07	75	0.44	-26
		1000	0.15	-166	5.1	82	0.09	75	0.42	-26
		1500	0.16	-176	3.5	75	0.14	74	0.44	-31
		2000	0.12	144	2.6	63	0.17	73	0.45	-32
		2500	0.17	133	2.2	55	0.22	70	0.43	-36
		3000	0.16	101	1.9	49	0.25	68	0.44	-39
		3500	0.28	98	1.6	41	0.29	65	0.41	-40
		4000	0.26	82	1.5	36	0.33	61	0.39	-47
	30	100	0.41	-65	34.3	134	0.01	70	0.74	-25
		200	0.30	-99	21.6	113	0.02	70	0.56	-28
		400	0.23	-131	11.9	98	0.04	76	0.47	-25
		600	0.20	-147	8.1	91	0.06	76	0.45	-24
		800	0.18	-163	6.1	84	0.07	78	0.44	-23
		1000	0.17	-177	5.0	80	0.09	78	0.43	-24
		1500	0.18	174	3.4	70	0.13	76	0.45	-30
		2000	0.14	141	2.5	61	0.17	74	0.47	-31
		2500	0.20	131	2.1	54	0.21	71	0.45	-36
		3000	0.18	104	1.8	47	0.25	69	0.46	-39
		3500	0.31	100	1.6	40	0.29	65	0.42	-42
		4000	0.29	84	1.5	35	0.33	62	0.40	-48

Table 1. MMBR941LT1, T3 Common Emitter S-Parameters (continued)

VCE (Vdc)	IC (mA)	f (MHz)	NF <sub>min</sub> (dB)	Γ <sub>o</sub> (MAG, ANGLE)	r <sub>N</sub>
6	5	1000	1.5	0.33 ∠ 77	0.28
		1500	1.75	0.26 ∠ 141	0.3

Table 2. MRF947 Series Typical Noise Parameters

VCE (Volts)	IC (mA)	f (MHz)	S <sub>11</sub>		S <sub>21</sub>		S <sub>12</sub>		S <sub>22</sub>	
			Mag	∠φ	Mag	∠φ	Mag	∠φ	Mag	∠φ
1.0	0.5	100	0.966	-11	1.776	170	0.031	83	0.998	-5
		200	0.956	-23	1.735	161	0.061	75	0.991	-9
		500	0.892	-55	1.587	132	0.135	55	0.923	-21
		900	0.749	-91	1.355	104	0.185	35	0.827	-34
		1000	0.720	-100	1.300	98	0.190	32	0.808	-36
		1500	0.637	-134	1.057	73	0.196	18	0.743	-47
		2000	0.587	-164	0.883	53	0.176	12	0.708	-58
		3000	0.572	149	0.672	27	0.149	33	0.680	-82
	1.0	100	0.941	-14	3.391	168	0.031	81	0.991	-6
		200	0.921	-28	3.285	158	0.060	73	0.974	-12
		500	0.806	-65	2.844	128	0.123	51	0.852	-27
		900	0.638	-104	2.196	101	0.158	35	0.717	-39
		1500	0.533	-146	1.580	72	0.168	25	0.619	-50
		2000	0.495	-174	1.281	55	0.164	25	0.581	-60
2.0	0.5	100	0.979	-9	1.827	173	0.030	85	0.996	-4
		200	0.960	-18	1.909	165	0.060	80	0.991	-9
		500	0.920	-43	1.652	144	0.132	65	0.940	-19
		1000	0.749	-77	1.451	116	0.196	47	0.842	-32
		1500	0.674	-105	1.190	94	0.214	36	0.774	-39
		2000	0.548	-128	1.077	79	0.189	33	0.692	-43
		3000	0.480	-178	0.808	60	0.153	55	0.625	-52
		2.0	100	0.907	-16	6.640	167	0.029	81	0.977
	200		0.846	-32	6.419	156	0.054	73	0.944	-17
	500		0.711	-68	4.874	128	0.104	57	0.770	-32
	1000		0.495	-106	3.178	103	0.138	50	0.603	-41
	1500		0.405	-131	2.358	86	0.157	52	0.542	-45
	2000		0.314	-155	1.910	75	0.173	58	0.490	-44
	5.0	100	0.780	-28	14.100	159	0.027	78	0.932	-15
200		0.676	-51	12.219	142	0.046	67	0.831	-27	
500		0.470	-95	7.373	113	0.078	59	0.568	-40	
1000		0.327	-132	4.148	92	0.114	62	0.436	-43	
1500		0.271	-153	2.921	81	0.151	66	0.413	-44	
2000		0.218	-177	2.295	72	0.188	69	0.394	-41	
3000		0.237	138	1.661	58	0.265	70	0.372	-43	

Table 3. MRF947 Series Common Emitter S-Parameters



VCE (Volts)	I <sub>C</sub> (mA)	f (MHz)	S <sub>11</sub>		S <sub>21</sub>		S <sub>12</sub>		S <sub>22</sub>	
			Mag	∠φ	Mag	∠φ	Mag	∠φ	Mag	∠φ
2.0	10	100	0.608	-43	21.812	149	0.022	72	0.859	-23
		200	0.488	-73	16.618	129	0.038	65	0.689	-35
		500	0.330	-119	8.427	103	0.065	66	0.438	-41
		1000	0.262	-152	4.484	87	0.109	71	0.354	-40
		1500	0.227	-169	3.114	77	0.155	73	0.358	-42
		2000	0.197	166	2.423	69	0.198	73	0.355	-38
		3000	0.233	128	1.755	57	0.281	71	0.338	-40
	30	100	0.353	-100	25.543	131	0.018	70	0.653	-29
		200	0.353	-135	15.823	112	0.026	68	0.484	-34
		500	0.346	-163	6.979	93	0.054	76	0.367	-29
		1000	0.337	177	3.637	80	0.103	79	0.351	-30
		1500	0.324	166	2.518	71	0.150	79	0.372	-36
		2000	0.319	148	1.975	63	0.197	78	0.378	-35
		3000	0.374	122	1.441	51	0.290	75	0.363	-42
6.0	0.5	100	0.978	-9	1.791	173	0.024	86	0.995	-4
		200	0.964	-17	1.889	166	0.049	80	0.994	-7
		500	0.932	-40	1.643	146	0.110	67	0.953	-16
		1000	0.765	-73	1.473	121	0.165	50	0.869	-28
		1500	0.688	-100	1.206	98	0.184	39	0.812	-35
		2000	0.554	-123	1.099	84	0.162	38	0.735	-38
		3000	0.463	-174	0.823	64	0.136	63	0.671	-46
	2.0	100	0.918	-15	6.614	168	0.023	84	0.983	-7
		200	0.862	-29	6.456	157	0.045	75	0.956	-14
		500	0.729	-62	5.010	131	0.089	60	0.809	-27
		1000	0.504	-99	3.344	106	0.121	53	0.654	-35
		1500	0.397	-123	2.485	90	0.137	55	0.599	-38
		2000	0.295	-146	2.013	78	0.152	62	0.553	-37
		3000	0.257	162	1.452	62	0.202	73	0.523	-40
	5.0	100	0.806	-24	14.025	161	0.022	78	0.947	-13
		200	0.704	-45	12.425	144	0.040	70	0.861	-23
		500	0.487	-85	7.751	116	0.068	62	0.627	-33
		1000	0.316	-120	4.399	95	0.101	65	0.505	-35
		1500	0.245	-141	3.112	83	0.134	69	0.488	-36
		2000	0.177	-166	2.447	74	0.167	72	0.473	-33
		3000	0.185	140	1.743	61	0.237	74	0.457	-36
	10	100	0.657	-37	22.098	151	0.019	75	0.888	-18
		200	0.526	-64	17.304	132	0.033	68	0.741	-29
		500	0.328	-105	9.028	106	0.056	67	0.509	-33
		1000	0.228	-138	4.844	89	0.096	73	0.438	-31
		1500	0.184	-156	3.359	80	0.138	75	0.440	-34
		2000	0.140	175	2.591	72	0.175	76	0.441	-31
		3000	0.172	126	1.852	60	0.249	75	0.430	-33
	20	100	0.492	-53	28.934	142	0.017	72	0.808	-23
		200	0.372	-85	19.971	121	0.028	70	0.630	-31
		500	0.249	-127	9.335	100	0.053	74	0.454	-28
		1000	0.201	-156	4.878	86	0.094	78	0.418	-27
		1500	0.174	-171	3.358	77	0.138	79	0.432	-30
		2000	0.149	161	2.580	70	0.177	78	0.444	-28
		3000	0.193	121	1.852	58	0.253	76	0.435	-32

Table 3. MRF947 Series Common Emitter S-Parameters (continued)

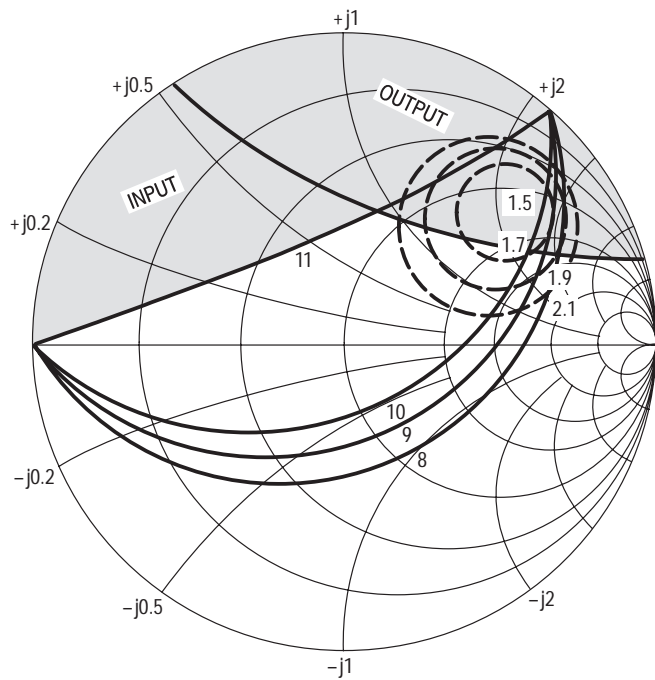

$V_{CE} = 1.0\text{ V}$   
 $I_C = 0.5\text{ mA}$   
 □ — AREA OF INSTABILITY

f (GHz)	NF OPT (dB)	$\Gamma_{MS}$ NF OPT	$R_N$	K
0.5	1.54	$0.71 \angle 39^\circ$	38	0.28

Figure 14. MMBR941LT1, T3 Constant Gain and Noise Figure Contours (f = 1.0 GHz)

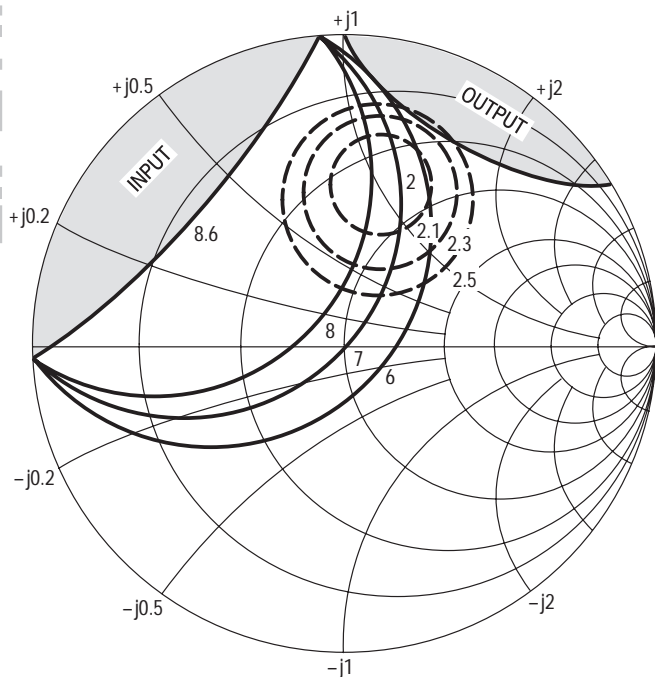

$V_{CE} = 1.0\text{ V}$   
 $I_C = 0.5\text{ mA}$   
 □ — AREA OF INSTABILITY

f (GHz)	NF OPT (dB)	$\Gamma_{MS}$ NF OPT	$R_N$	K
1.0	1.95	$0.55 \angle 76^\circ$	28	0.51

Figure 15. MMBR941LT1, T3 Constant Gain and Noise Figure Contours (f = 0.5 GHz)

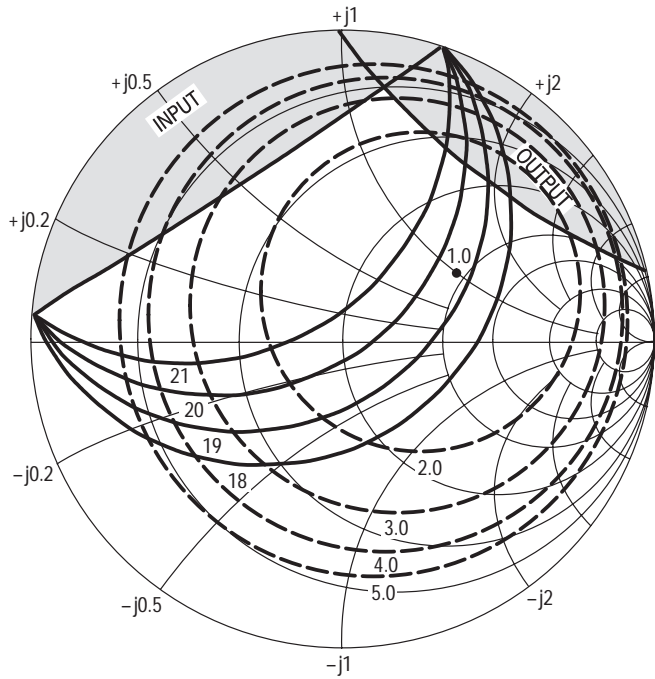

$V_{CE} = 6.0 \text{ V}$   
 $I_C = 5.0 \text{ mA}$   
 [shaded box] — AREA OF INSTABILITY

f (GHz)	NF OPT (dB)	$\Gamma_{MS}$ NF OPT	$R_N$	K
0.5	1.0	$0.43 \angle 30^\circ$	18	0.58

Figure 16. MMBR941LT1, T3 Constant Gain and Noise Figure Contours (f = 0.5 GHz)

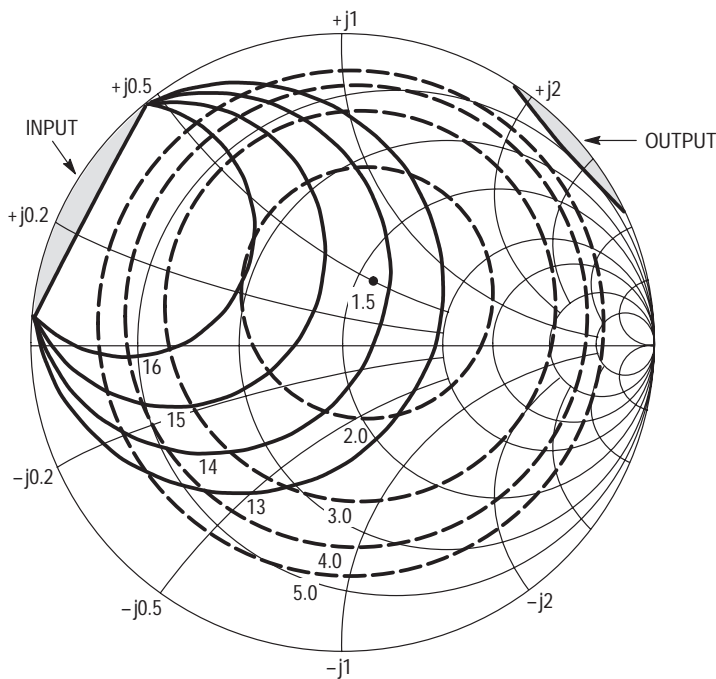

$V_{CE} = 6.0 \text{ V}$   
 $I_C = 5.0 \text{ mA}$   
 [shaded box] — AREA OF INSTABILITY

f (GHz)	NF OPT (dB)	$\Gamma_{MS}$ NF OPT	$R_N$	K
1.0	1.5	$0.22 \angle 64^\circ$	13	0.93

Figure 17. MMBR941LT1, T3 Constant Gain and Noise Figure Contours (f = 1.0 GHz)

$V_{CE} = 6\text{ V}$   
 $I_C = 5\text{ mA}$

f (GHz)	NF OPT	$\Gamma_O$	$R_N$	K
1.0	1.5 dB	$0.33 \angle 77^\circ$	14	0.87

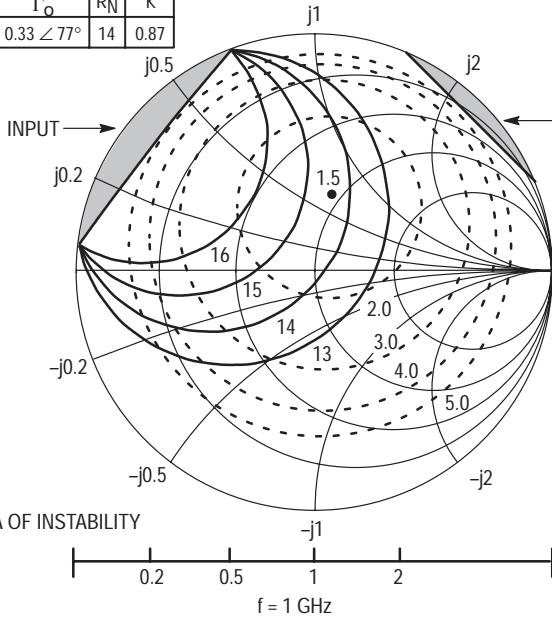

Figure 18. MRF947 Series Constant Gain and Noise Figure Contours

$V_{CE} = 6\text{ V}$   
 $I_C = 5\text{ mA}$

f (GHz)	NF OPT	$\Gamma_O$	$R_N$	K
1.5	1.75 dB	$0.26 \angle 141^\circ$	15	0.96

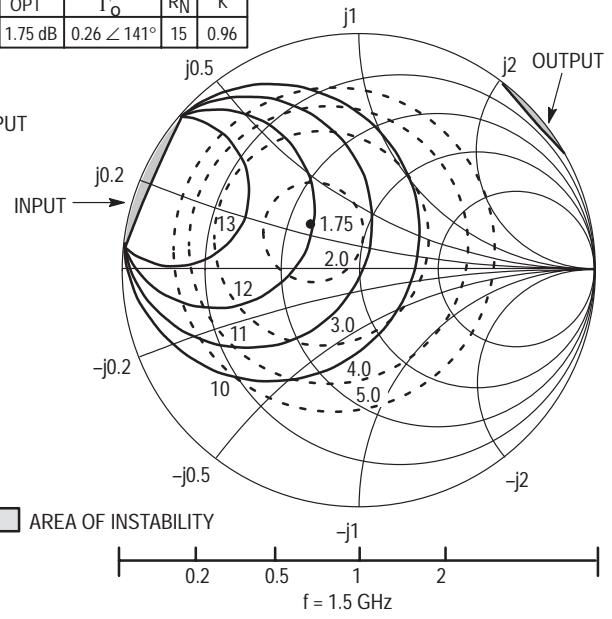

Figure 19. MRF947 Series Constant Gain and Noise Figure Contours

$V_{CE} = 1\text{ V}$   
 $I_C = 0.5\text{ mA}$

f (GHz)	NF OPT	$\Gamma_{MS}$ NF OPT	$R_N$	K
1.0	1.95 dB	$0.59 \angle 72^\circ$	30	0.50

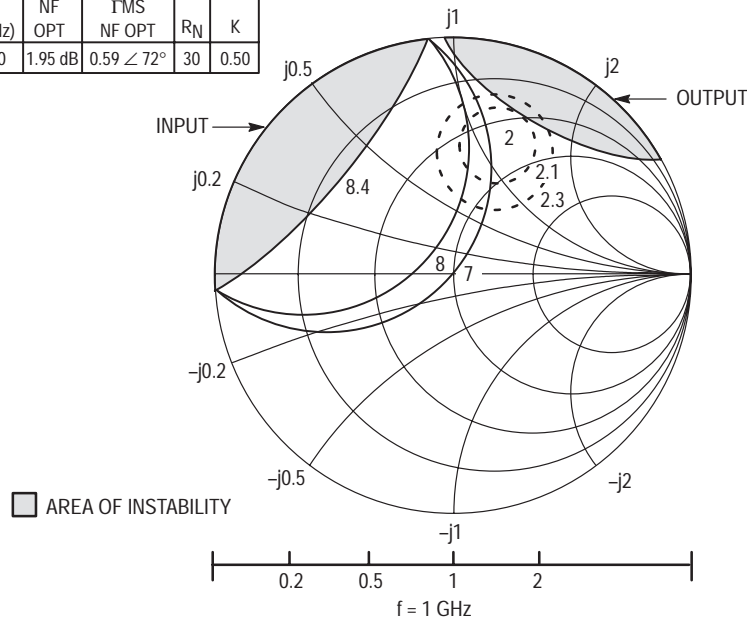
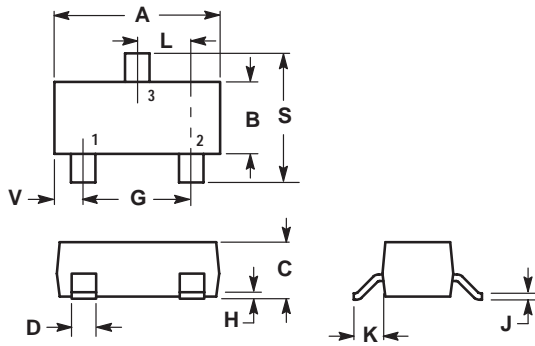

Figure 20. MRF947 Series Constant Gain and Noise Figure Contours

PACKAGE DIMENSIONS



NOTES:

1. DIMENSIONING AND TOLERANCING PER ANSI Y14.5M, 1982.
2. CONTROLLING DIMENSION: INCH.
3. MAXIMUM LEAD THICKNESS INCLUDES LEAD FINISH THICKNESS. MINIMUM LEAD THICKNESS IS THE MINIMUM THICKNESS OF BASE MATERIAL.

DIM	INCHES		MILLIMETERS	
	MIN	MAX	MIN	MAX
A	0.1102	0.1197	2.80	3.04
B	0.0472	0.0551	1.20	1.40
C	0.0350	0.0440	0.89	1.11
D	0.0150	0.0200	0.37	0.50
G	0.0701	0.0807	1.78	2.04
H	0.0005	0.0040	0.013	0.100
J	0.0034	0.0070	0.085	0.177
K	0.0140	0.0285	0.35	0.69
L	0.0350	0.0401	0.89	1.02
S	0.0830	0.1039	2.10	2.64
V	0.0177	0.0236	0.45	0.60

STYLE 6:

1. BASE
2. EMITTER
3. COLLECTOR

CASE 318-08  
ISSUE AF  
MMBR941LT1, T3, MMBR941BLT1

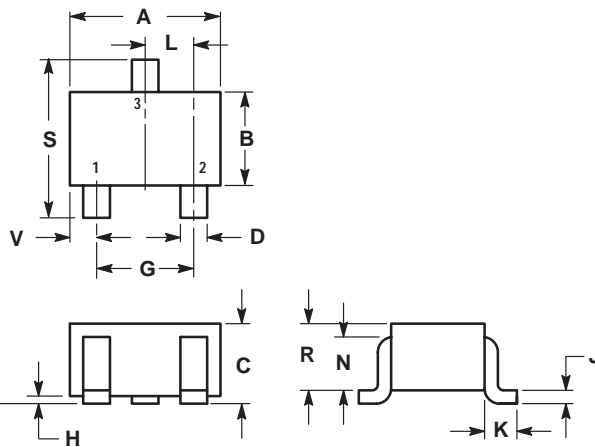

NOTES:

1. DIMENSIONING AND TOLERANCING PER ANSI Y14.5M, 1982.
2. CONTROLLING DIMENSION: INCH.

DIM	INCHES		MILLIMETERS	
	MIN	MAX	MIN	MAX
A	0.071	0.087	1.80	2.20
B	0.045	0.053	1.15	1.35
C	0.035	0.049	0.90	1.25
D	0.012	0.016	0.30	0.40
G	0.047	0.055	1.20	1.40
H	0.000	0.004	0.00	0.10
J	0.004	0.010	0.10	0.25
K	0.017 REF		0.425 REF	
L	0.026 BSC		0.650 BSC	
N	0.028 REF		0.700 REF	
R	0.031	0.039	0.80	1.00
S	0.079	0.087	2.00	2.20
V	0.012	0.016	0.30	0.40

STYLE 3:

1. BASE
2. EMITTER
3. COLLECTOR

CASE 419-02  
ISSUE J  
MRF947AT1, MRF947BT1,  
MRF947T1, T3

0.05 (0.002)

LIFETIME BUY

LAST SHIP: 26MAR02

LAST ORDER: 25SEP01

LIFETIME BUY

LAST ORDER: 25SEP01 LAST SHIP: 26MAR02

Motorola reserves the right to make changes without further notice to any products herein. Motorola makes no warranty, representation or guarantee regarding the suitability of its products for any particular purpose, nor does Motorola assume any liability arising out of the application or use of any product or circuit, and specifically disclaims any and all liability, including without limitation consequential or incidental damages. "Typical" parameters which may be provided in Motorola data sheets and/or specifications can and do vary in different applications and actual performance may vary over time. All operating parameters, including "Typicals" must be validated for each customer application by customer's technical experts. Motorola does not convey any license under its patent rights nor the rights of others. Motorola products are not designed, intended, or authorized for use as components in systems intended for surgical implant into the body, or other applications intended to support or sustain life, or for any other application in which the failure of the Motorola product could create a situation where personal injury or death may occur. Should Buyer purchase or use Motorola products for any such unintended or unauthorized application, Buyer shall indemnify and hold Motorola and its officers, employees, subsidiaries, affiliates, and distributors harmless against all claims, costs, damages, and expenses, and reasonable attorney fees arising out of, directly or indirectly, any claim of personal injury or death associated with such unintended or unauthorized use, even if such claim alleges that Motorola was negligent regarding the design or manufacture of the part. Motorola and  are registered trademarks of Motorola, Inc. Motorola, Inc. is an Equal Opportunity/Affirmative Action Employer.

Mfax is a trademark of Motorola, Inc.

**How to reach us:**

**USA/EUROPE/Locations Not Listed:** Motorola Literature Distribution;  
P.O. Box 5405, Denver, Colorado 80217. 1-303-675-2140 or 1-800-441-2447

**JAPAN:** Motorola Japan Ltd.; SPD, Strategic Planning Office, 141,  
4-32-1 Nishi-Gotanda, Shinagawa-ku, Tokyo, Japan. 81-3-5487-8488

**Customer Focus Center: 1-800-521-6274**

**Mfax™:** RMFAX0@email.sps.mot.com – TOUCHTONE 1-602-244-6609  
Motorola Fax Back System – US & Canada ONLY 1-800-774-1848  
– http://sps.motorola.com/mfax/

**ASIA/PACIFIC:** Motorola Semiconductors H.K. Ltd.; 8B Tai Ping Industrial Park,  
51 Ting Kok Road, Tai Po, N.T., Hong Kong. 852-26629298

**HOME PAGE:** <http://motorola.com/sps/>



MMBR941/D