

SBD Type : NSQ03A03L

FEATURES

- * **FLAT-PAK** Surface Mounting Device
- * Extremely Low Forward Voltage Drop
- * Low Power Loss, High Efficiency
- * High Surge Capability
- * 30 Volts through 60Volts Types Available
- * Packaged in 16mm Tape and Reel
- * Not Rolling During Assembly

OUTLINE DRAWING

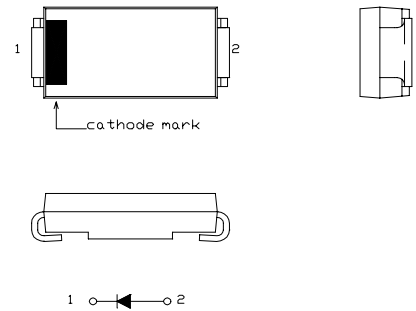

Maximum Ratings

Approx Net Weight: 0.16g

Rating	Symbol	NSQ03A03L			Unit
Repetitive Peak Reverse Voltage	V_{RRM}	30			V
Average Rectified Output Current	I_o	1.6	$T_a=25^{\circ}C$ *1	50Hz Half Sine	A
		3.0	$T_l=103^{\circ}C$	Wave Resistive Load	
RMS Forward Current	$I_{F(RMS)}$	4.71			A
Surge Forward Current	I_{FSM}	100	50Hz Half Sine Wave, 1cycle Non-repetitive		A
Operating Junction Temperature Range	T_{jw}	-40 to +150			$^{\circ}C$
Storage Temperature Range	T_{stg}	-40 to +150			$^{\circ}C$

Electrical • Thermal Characteristics

Characteristics		Symbol	Conditions	Min.	Typ.	Max.	Unit
Peak Reverse Current		I_{RM}	$T_j= 25^{\circ}C, V_{RM}= V_{RRM}$	-	-	3	mA
Peak Forward Voltage		V_{FM}	$T_j= 25^{\circ}C, I_{FM}= 3.0A$	-	-	0.45	V
Thermal Resistance	Junction to Ambient	$R_{th(j-a)}$	Alumina Substrate Mounted *1	-	-	89	$^{\circ}C/W$
	Junction to Lead	$R_{th(j-l)}$	-	-	-	13	

*1 Alumina Substrate Mounted (Soldering Lands=2x3.5mm, Both Sides)
(T_l : Lead Temperature)

NSQ03A03L OUTLINE DRAWING (Dimensions in mm)

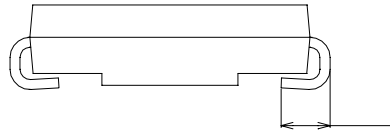
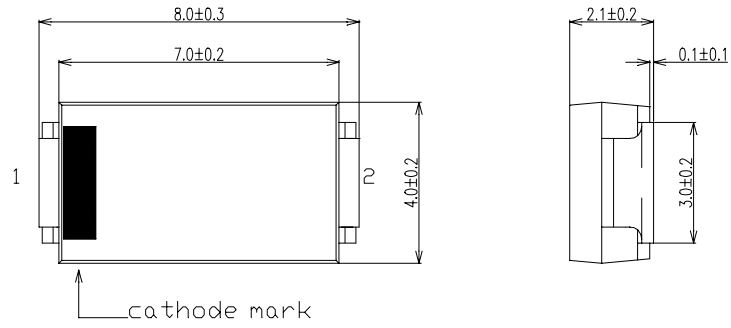

FORWARD CURRENT VS. VOLTAGE

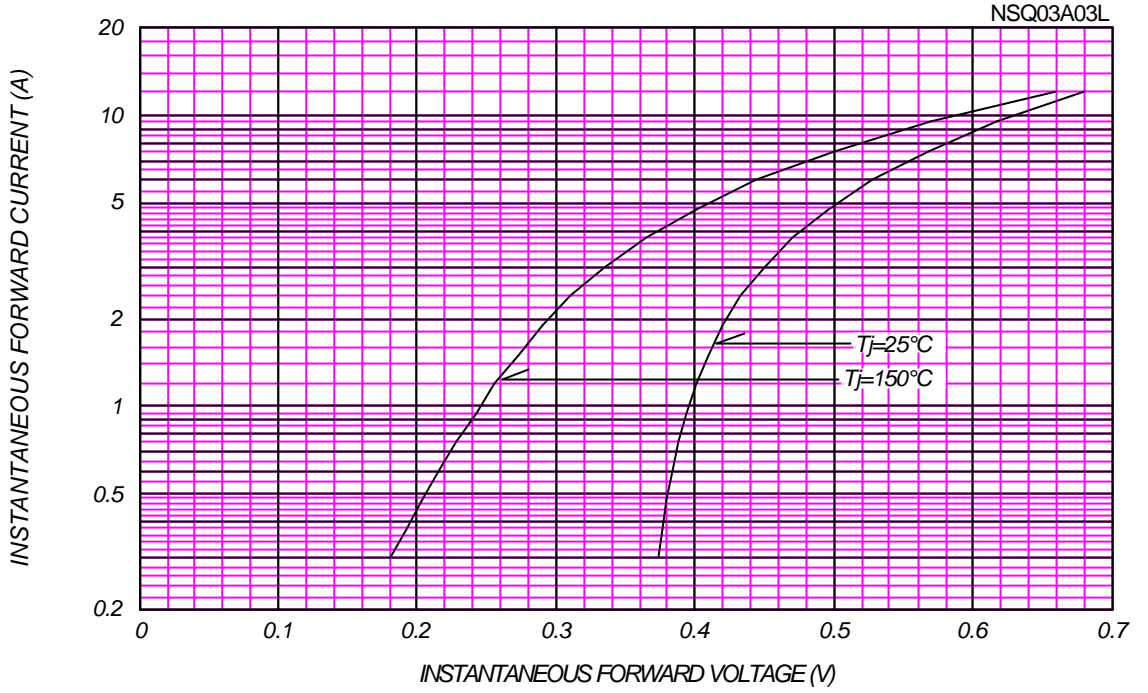

AVERAGE FORWARD POWER DISSIPATION

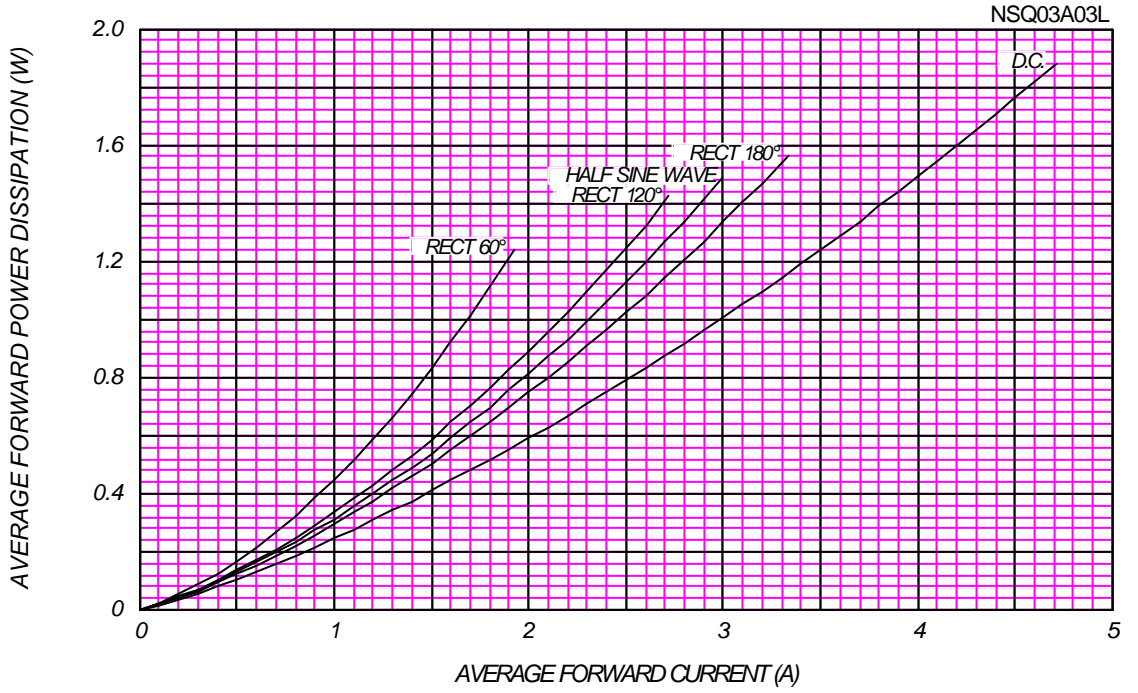

PEAK REVERSE CURRENT VS. PEAK REVERSE VOLTAGE

$T_j = 150\text{ }^\circ\text{C}$

NSQ03A03L

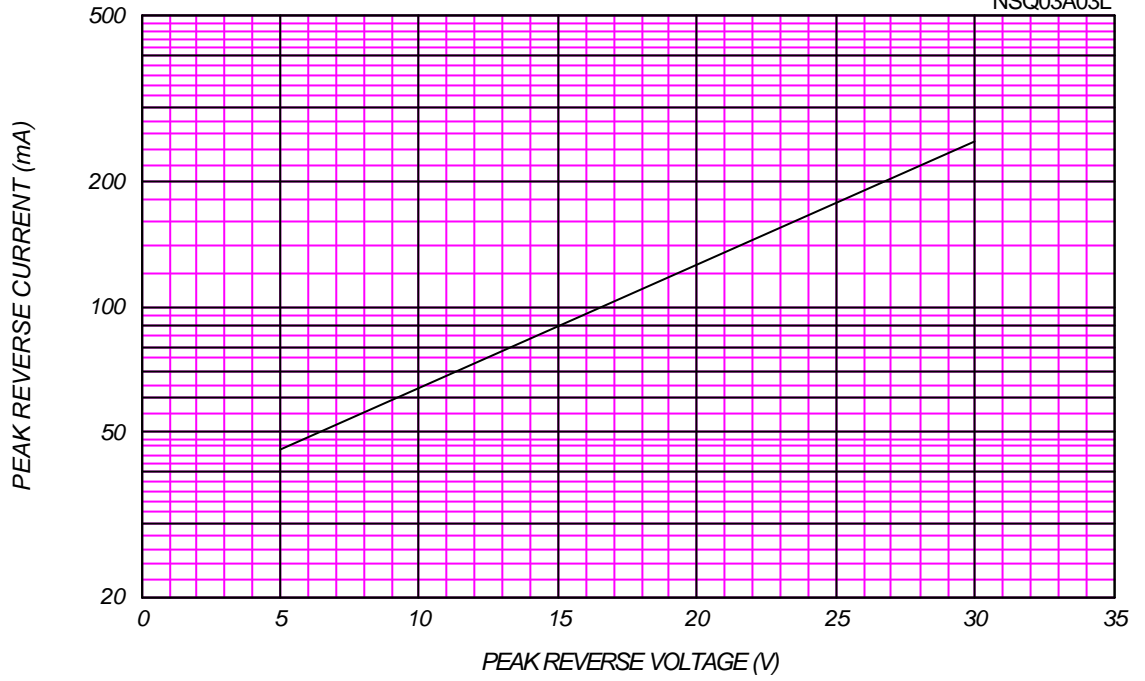

AVERAGE REVERSE POWER DISSIPATION

NSQ03A03L

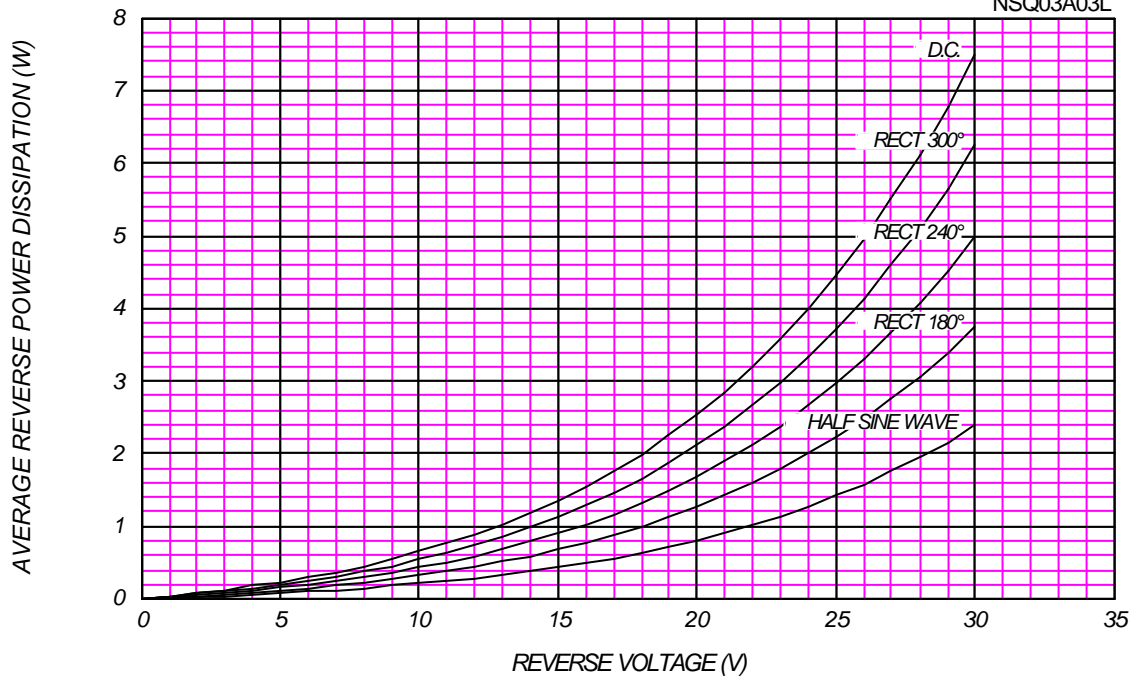



AVERAGE FORWARD CURRENT VS. AMBIENT TEMPERATURE

Alumina Substrate Mounted (Soldering Land=2x3.5mm), $V_{RM}=30V$

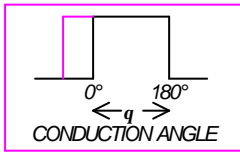
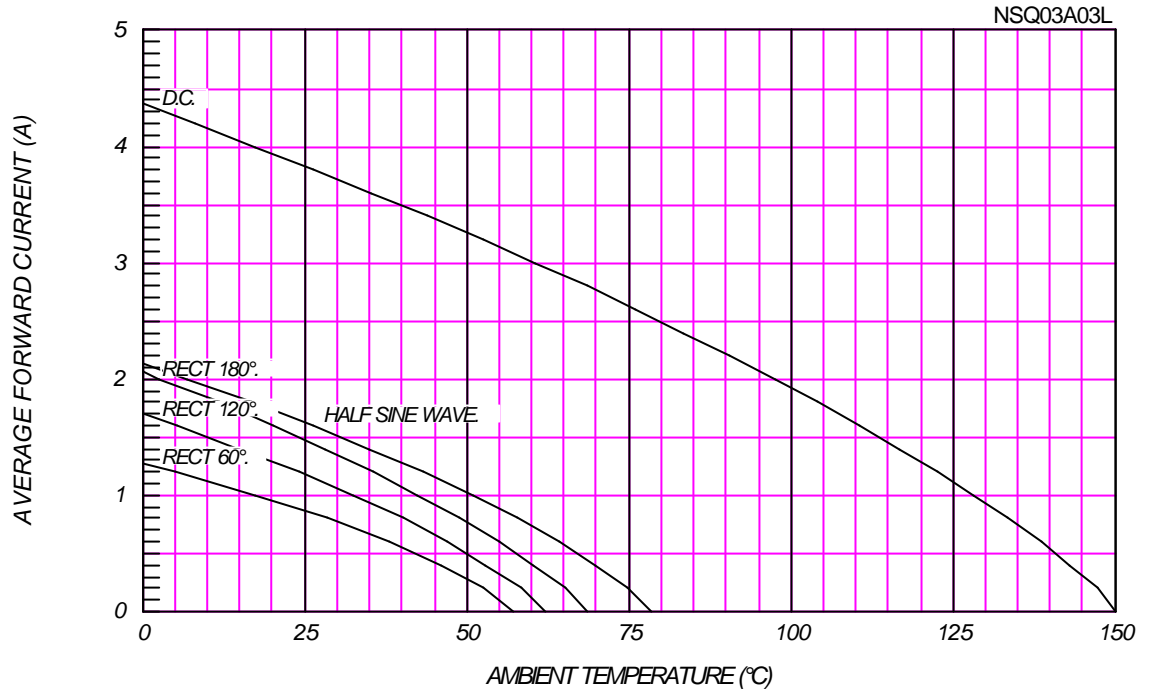

AVERAGE FORWARD CURRENT VS. LEAD TEMPERATURE

$V_{RM}=30V$

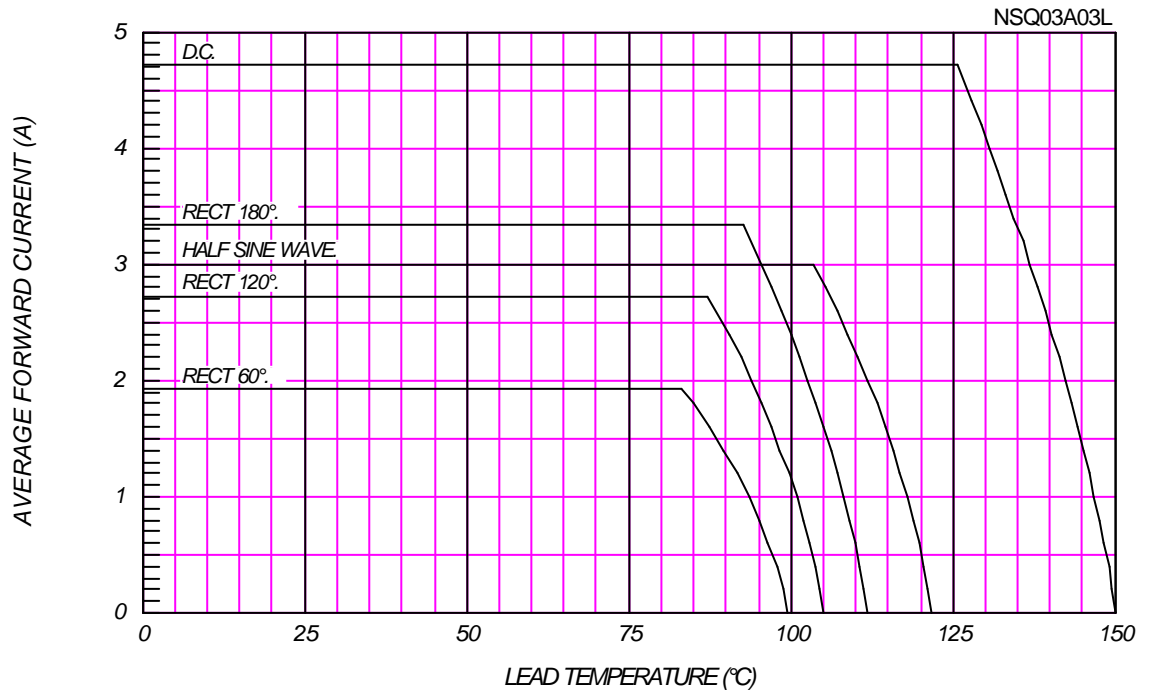

SURGE CURRENT RATINGS

f=50Hz, Half Sine Wave, Non-Repetitive, No Load

NSQ03A03L

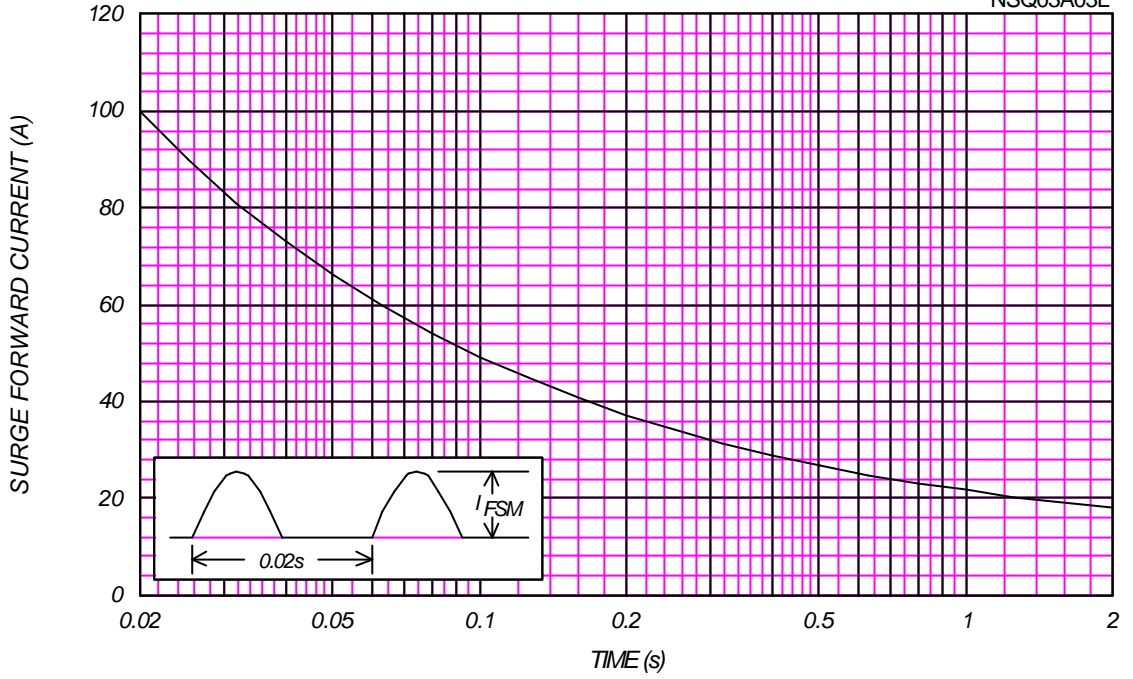

JUNCTION CAPACITANCE VS. REVERSE VOLTAGE

T_j=25° C, V_m=20mV_{RMS}, f=100kHz, Typical Value

NSQ03A03L

