

SBD Type : NSQ03A04

FEATURES

- * **FLAT-PAK** Surface Mounting Device
- * Low Forward Voltage Drop
- * Low Power Loss, High Efficiency
- * High Surge Capability
- * 30 Volts through 60Volts Types Available
- * Packaged in 16mm Tape and Reel
- * Not Rolling During Assembly

OUTLINE DRAWING

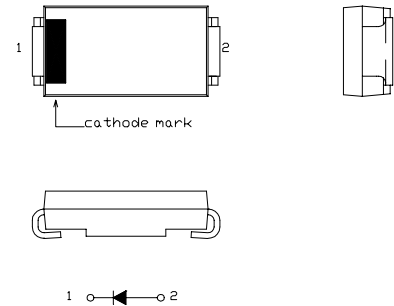

Maximum Ratings

Approx Net Weight: 0.16g

Rating	Symbol	NSQ03A04		Unit
Repetitive Peak Reverse Voltage	V_{RRM}	40		V
Average Rectified Output Current	I_o	1.62	$T_a=25^{\circ}\text{C}$ *1	50Hz Half Sine Wave Resistive Load
		3.0	$T_l=113^{\circ}\text{C}$	
RMS Forward Current	$I_{F(RMS)}$	4.71		A
Surge Forward Current	I_{FSM}	80	50Hz Half Sine Wave, 1cycle Non-repetitive	A
Operating Junction Temperature Range	T_{jw}	-40 to +150		$^{\circ}\text{C}$
Storage Temperature Range	T_{stg}	-40 to +150		$^{\circ}\text{C}$

Electrical • Thermal Characteristics

Characteristics		Symbol	Conditions	Min.	Typ.	Max.	Unit
Peak Reverse Current		I_{RM}	$T_j= 25^{\circ}\text{C}$, $V_{RM}= V_{RRM}$	-	-	3	mA
Peak Forward Voltage		V_{FM}	$T_j= 25^{\circ}\text{C}$, $I_{FM}= 3.0\text{A}$	-	-	0.55	V
Thermal Resistance	Junction to Ambient	$R_{th(j-a)}$	Alumina Substrate Mounted *1	-	-	89	$^{\circ}\text{C}/\text{W}$
	Junction to Lead	$R_{th(j-l)}$	-	-	-	13	

*1 Alumina Substrate Mounted (Soldering Lands=2x3.5mm, Both Sides)
(T_l : Lead Temperature)

NSQ03A04 OUTLINE DRAWING (Dimensions in mm)

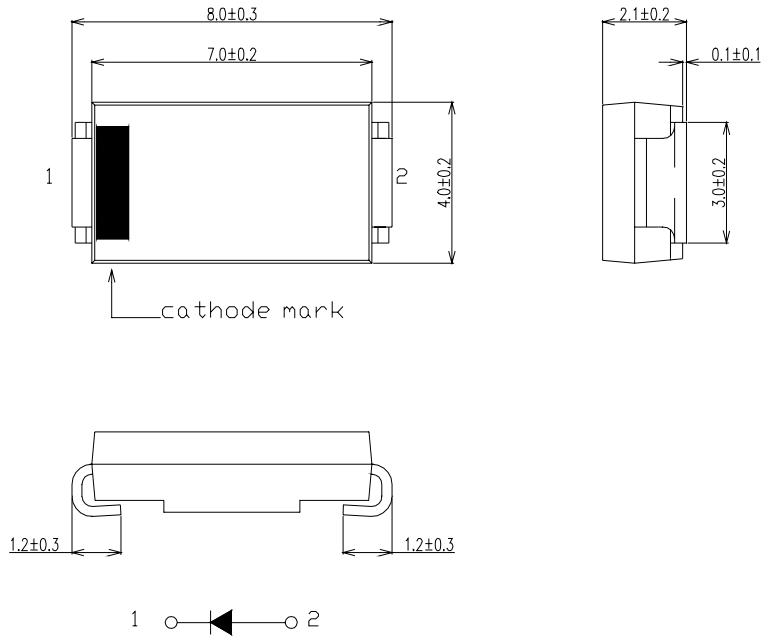

SOLDERING PAD

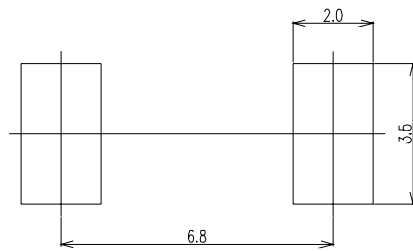

FORWARD CURRENT VS. VOLTAGE

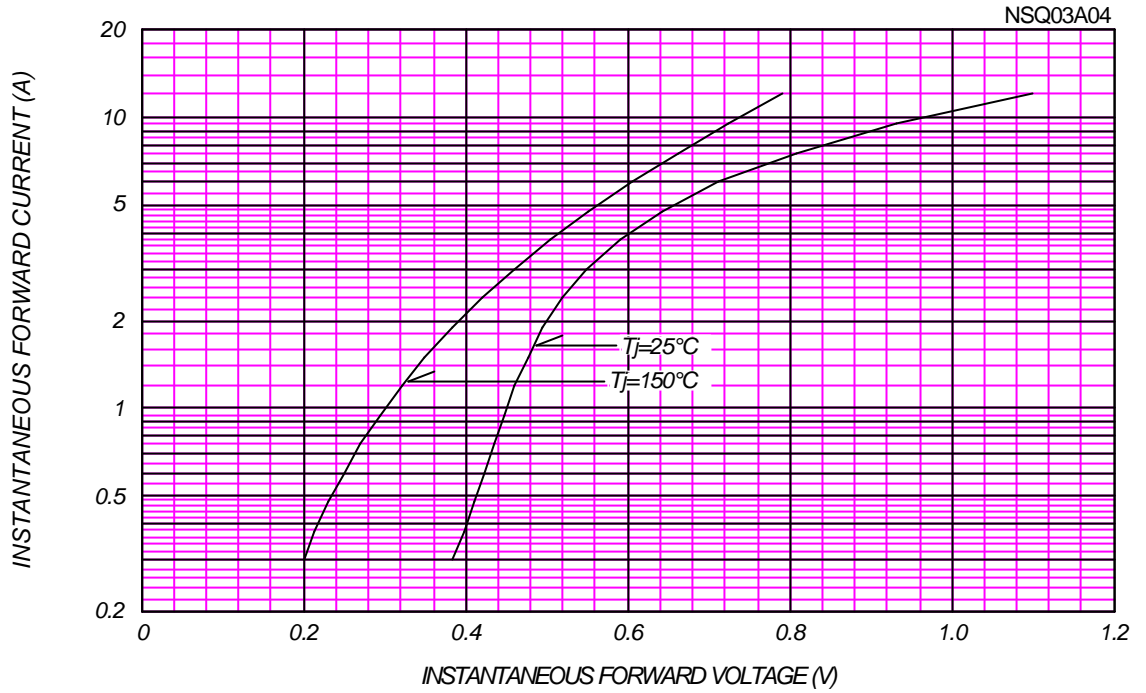

AVERAGE FORWARD POWER DISSIPATION

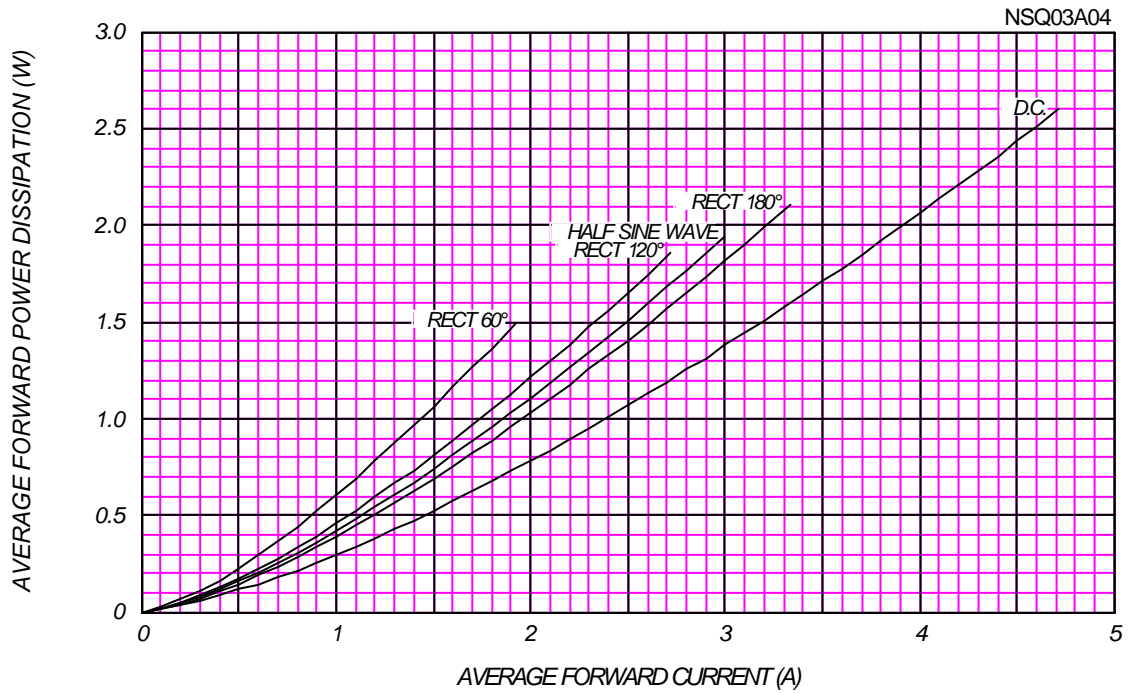

PEAK REVERSE CURRENT VS. PEAK REVERSE VOLTAGE

T_j = 150 °C

NSQ03A04

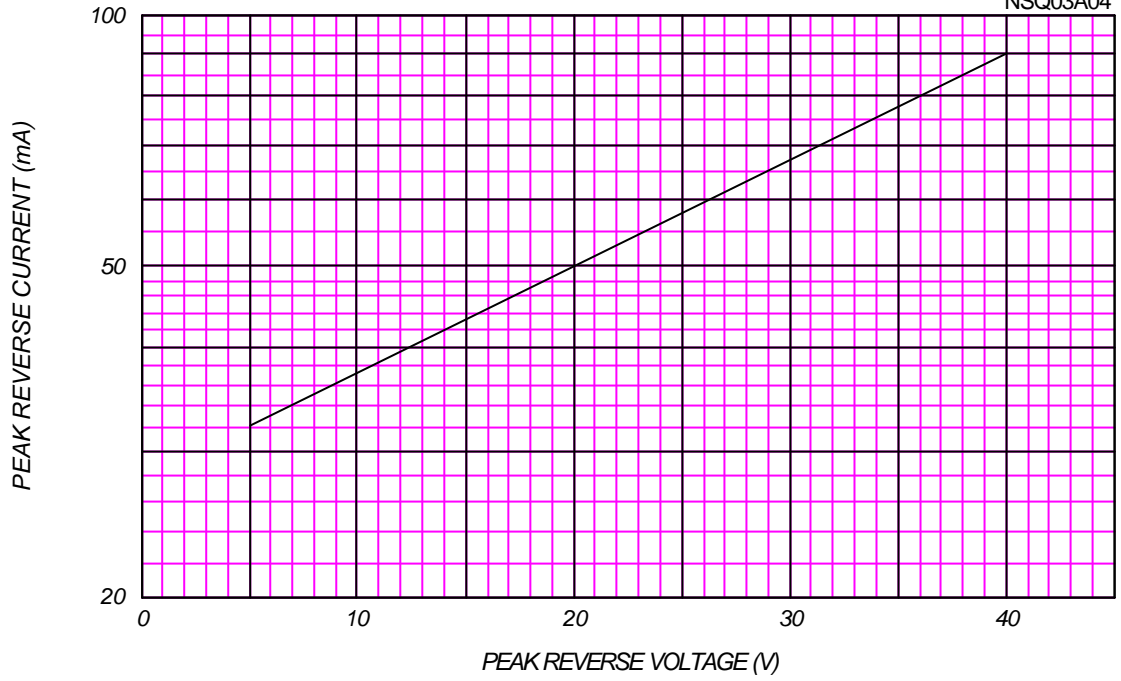

AVERAGE REVERSE POWER DISSIPATION

NSQ03A04

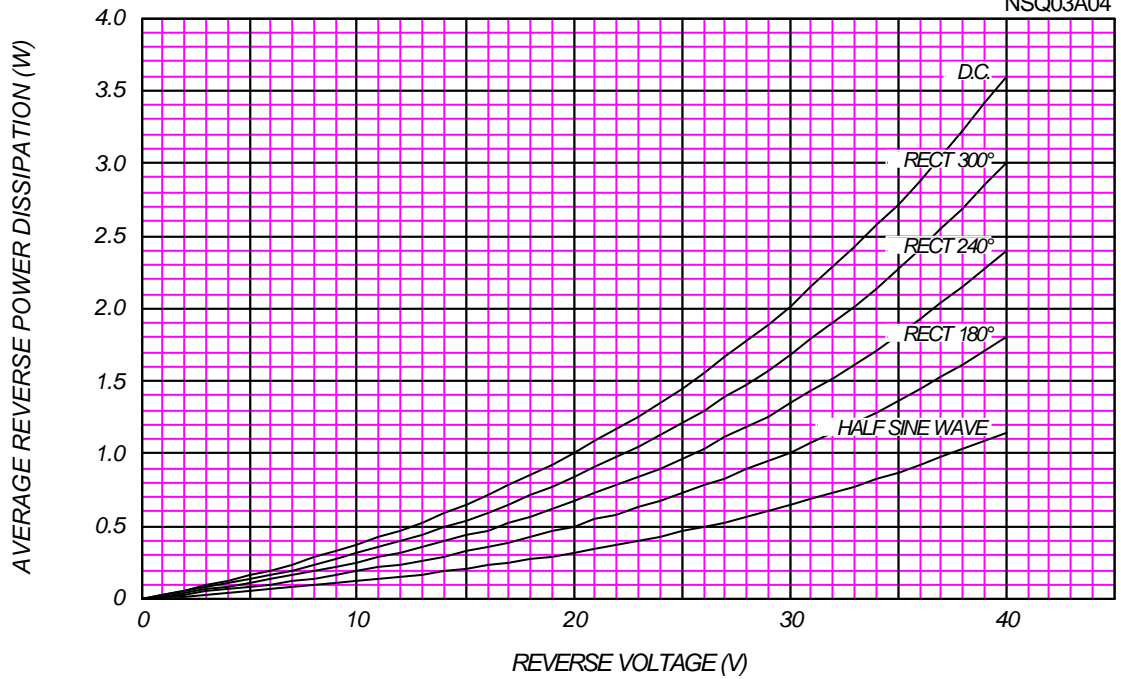



AVERAGE FORWARD CURRENT VS. AMBIENT TEMPERATURE

Alumina Substrate Mounted, $V_{RM}=40V$

NSQ03A04

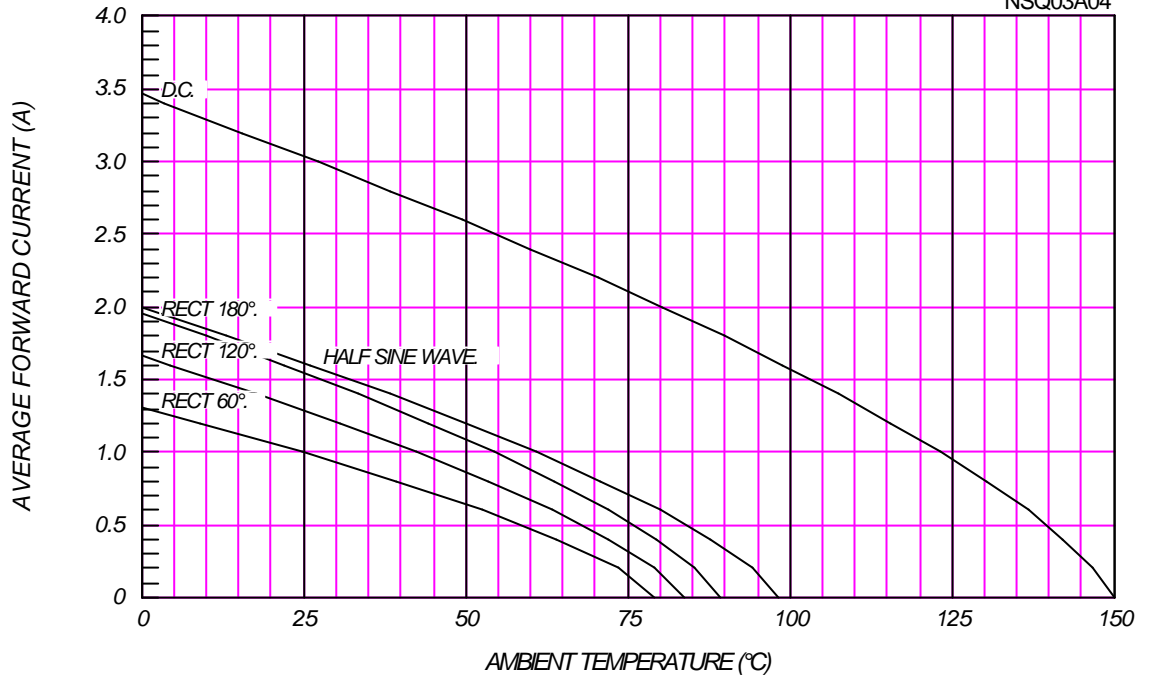

AVERAGE FORWARD CURRENT VS. LEAD TEMPERATURE

$V_{RM}=40V$

NSQ03A04

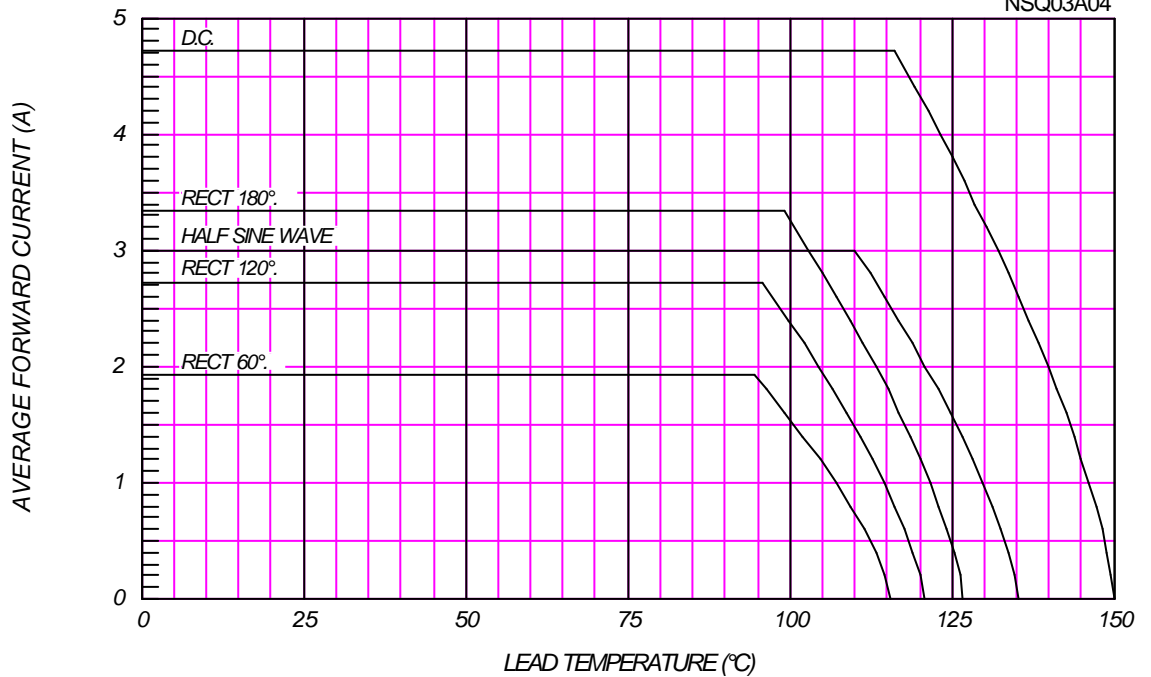

SURGE CURRENT RATINGS

f=50Hz, Half Sine Wave, Non-Repetitive, No Load

NSQ03A04

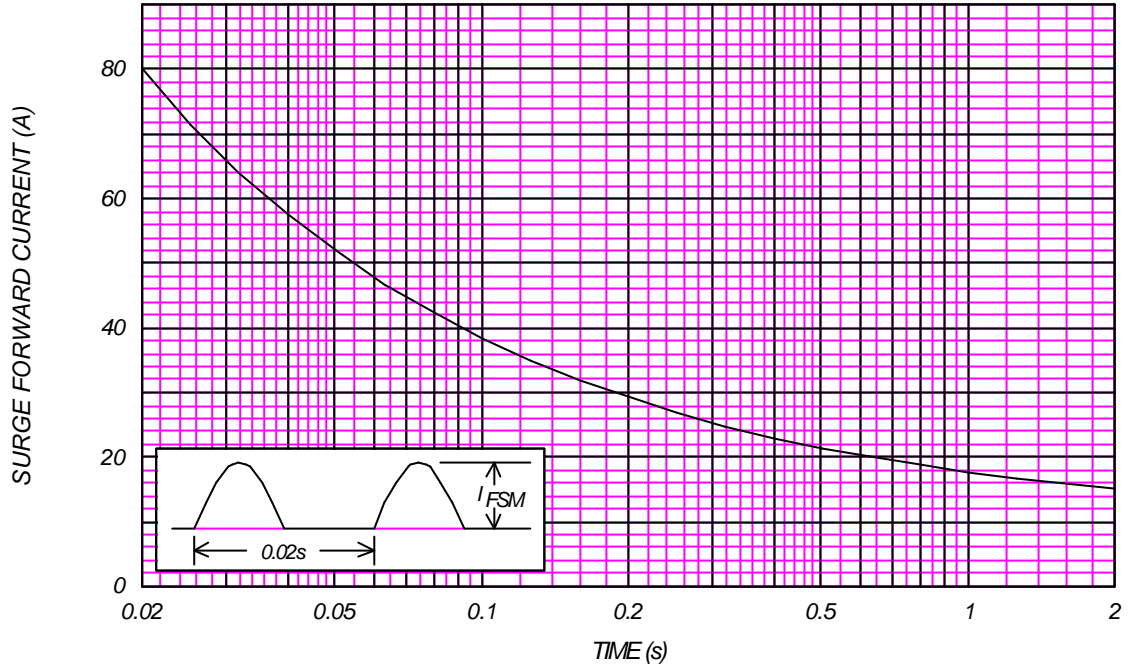

JUNCTION CAPACITANCE VS. REVERSE VOLTAGE

$T_j=25^\circ\text{C}$, $V_m=20\text{mV}_{RMS}$, $f=100\text{kHz}$, Typical Value

NSQ03A04

