

High-voltage switching diode

RLS245

●Applications

High voltage switching
General purpose rectification

●Features

- 1) High reliability
- 2) Small surface mounting type. (LLDS)
- 3) $V_{RM}=250V$ guaranteed.

●Construction

Silicon epitaxial planar

●External dimensions (Units : mm)

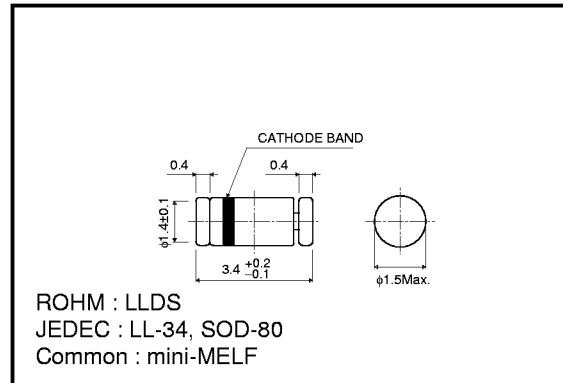

●Absolute maximum ratings (Ta=25°C)

Parameter	Symbol	Limits	Unit
Peak reverse voltage	V_{RM}	250	V
DC reverse voltage	V_R	220	V
Peak forward current	I_{FM}	625	mA
Mean rectifying current	I_O	200	mA
Surge current (1s)	I_{surge}	1000	mA
Power dissipation	P	300	mW
Junction temperature	T_j	175	°C
Storage temperature	T_{stg}	-65~+175	°C

●Cathode band colors

Type	Color
RLS245	WHITE

●Electrical characteristics (Ta=25°C)

Parameter	Symbol	Min.	Typ.	Max.	Unit	Conditions
Forward voltage	V_F	-	1.13	1.5	V	$I_F=200mA$
Reverse current	I_R	-	0.05	10	μA	$V_R=220V$
Capacitance between terminals	C_T	-	0.95	3	pF	$V_R=0V, f=1MHz$
Reverse recovery time	t_{rr}	-	-	75	ns	$I_F=20mA, I_R=20mA, R_L=50\Omega$

Diodes

● Electrical characteristic curves (Ta=25°C)

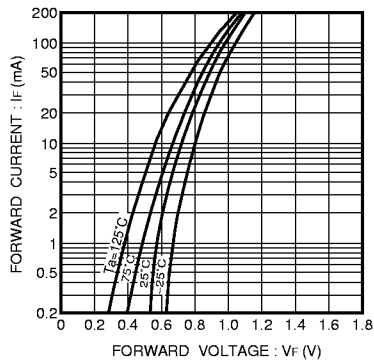

Fig. 1 Forward characteristics

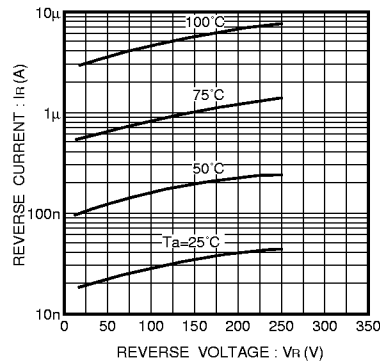

Fig. 2 Reverse characteristics

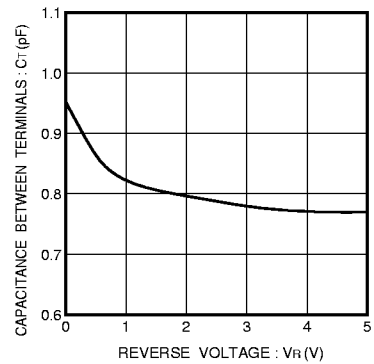

Fig. 3 Capacitance between terminals characteristics

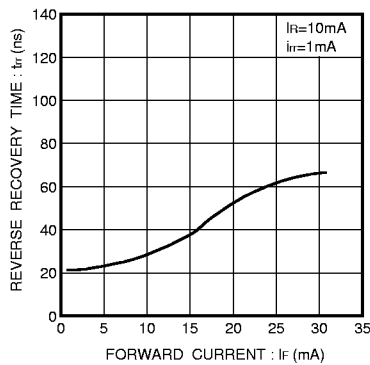

Fig. 4 Reverse recovery time characteristics

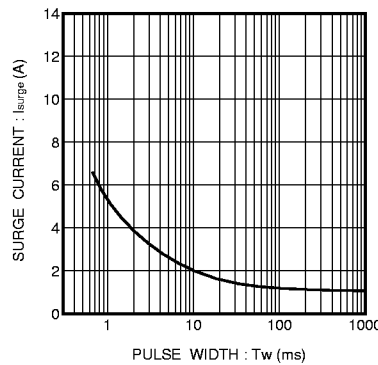

Fig. 5 Surge current characteristics

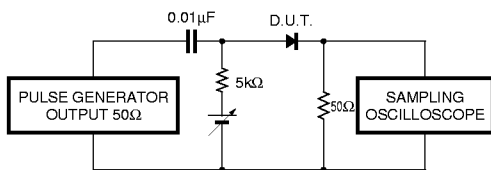

Fig. 6 Reverse recovery time (tr) measurement circuit