

## UHF-band Device Series

# KGF1145/1155/1165/1175/1255/KGA1301/KGL2115

### DESCRIPTION

The UHF band device series consists of analog devices and a digital device.

The analog devices include a Dual-Gate Buffer Amplifier, Dual-Gate Mixer Amplifier, Feedback Wide-band Amplifier, Dual-Gate Head Amplifier, Single-Gate Driver Amplifier and a Single-Gate Power Amplifier.

The digital device is a 2-modulus Prescaler.

Thanks to the low power consumption and low noise of GaAs devices, this series is perfect for application in portable Cellular phones.

### FEATURES

(Analog devices)

- Low Drain current Operation
- Self-bias Configuration
- Including Soura capacitor
- Mini-mold Package for Surface Mount
- High Isolation
- Low Noise Figure

(Digital device: the KGL2115, Prescaler)

- Low Power Consumption
- Wide Operation Temperature
- 8 pin Flat Package

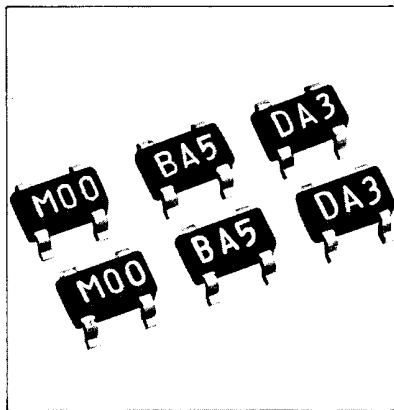

KGF1145/55/65/75  
KGF1255

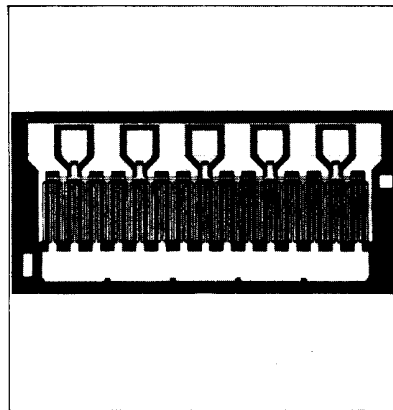

KGA1301

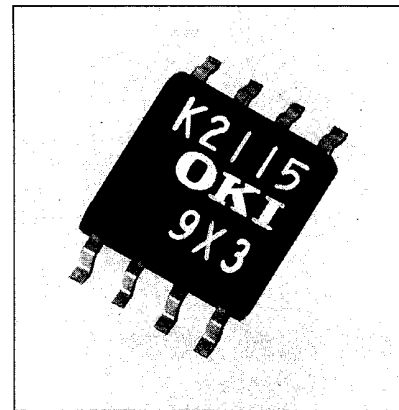

KGL2115

### FUNCTION TABLE

(\*) Under development

	Type	Functions	Specifications	Gate length/width	Package
Analog	KGF1145	Dual-Gate Buffer Amplifier	$F < 3\text{dB}$ $P_o > 2\text{dBm}$ $I_{DS} < 4\text{mA}$ $f = 850\text{MHz}$	0.5/300 $\mu\text{m}$	Mini-mold 4P
	KGF1155	Dual-Gate Mixer Amplifier	$F < 3\text{dB}$ $G_c > 12\text{dB}$ $I_{DS} < 2.5\text{mA}$ $f = 850\text{MHz}$	0.5/300 $\mu\text{m}$	Mini-mold 4P
	KGF1165	Feedback Wide-band Amplifier	$F < 4\text{dB}$ $P_o > 7\text{dBm}$ $I_{DS} < 25\text{mA}$ $f = 800\sim 900\text{MHz}$	0.5/1000 $\mu\text{m}$	Mini-mold 4P
	KGF1175	Dual-Gate Head Amplifier	$F < 2\text{dB}$ $P_o > 3\text{dBm}$ $I_{DS} < 2.5\text{mA}$ $f = 850\text{MHz}$	0.5/300 $\mu\text{m}$	Mini-mold 4P
	KGF1255	Single-Gate Driver Amplifier	$F < 2.5\text{dB}$ $P_o > 17\text{dBm}$ $I_{DS} < 80\text{mA}$ $f = 850\text{MHz}$	0.5/1800 $\mu\text{m}$	Mini-mold 4P
Digital	KGA1301	Single-Gate Power Amplifier.	$P_o > 31.5\text{dBm}$ $I_{DS} = 400\text{mA}$ $f = 850\text{MHz}$	1.0/7500 $\mu\text{m}$	Chip (Package-type)*
	KGL2115	2-modulus Prescaler	$I_{DD} < 6\text{mA}$ DR 1/128 1/129 $f = 1\text{GHz}$	1 $\mu\text{m}$ 60GATE (SCFL)	SOP 8P

NOTE: Device: MESFET, +5V power supply

F: Noise Figure  $P_o$ : Output Power  $I_{DS}$ : Drain Current  $f$ : Operating Frequency DR: Dividing Ratio SCFL: Source Coupled FET Logic

# PORTABLE CELLULAR PHONE APPLICATION

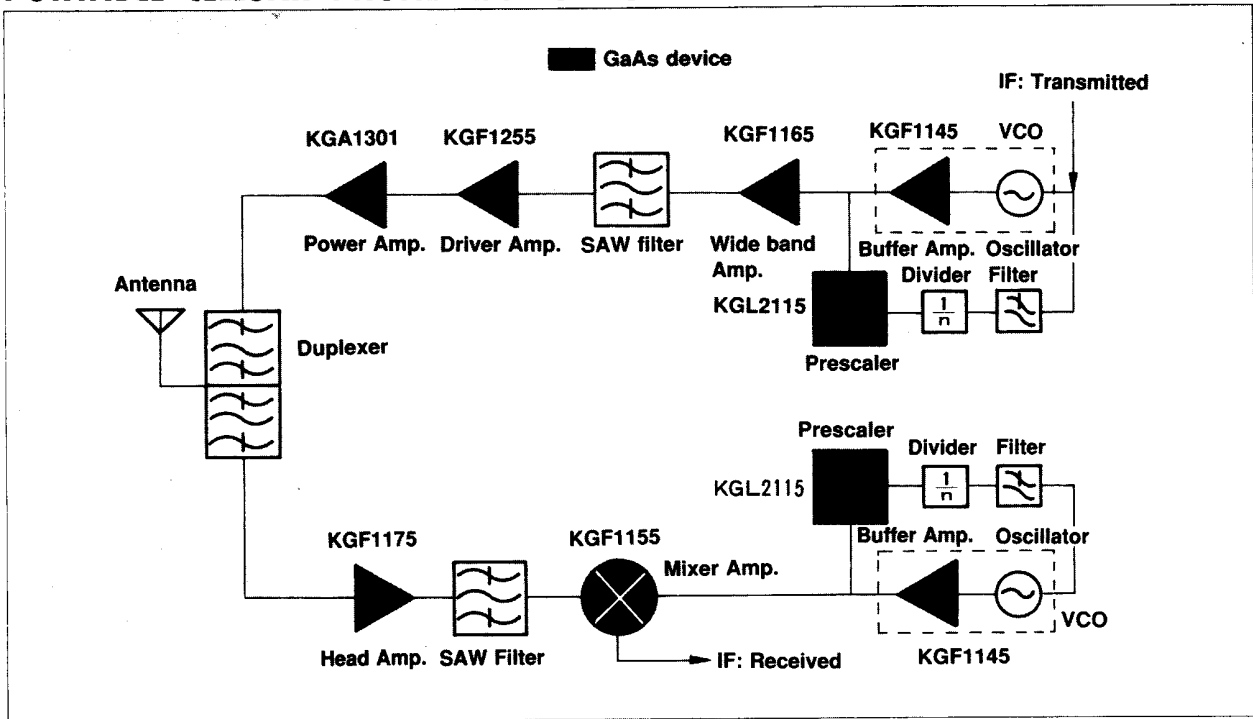

## MAXIMUM RATINGS (Analog Devices)

Parameter	Symbol	Unit	KGF1145	KGF1155	KGF1165	KGF1175	KGF1255	KGA1301
Drain Source Voltage	$V_{DS}$	V	6	7	7	7	7	7
Gate Source Voltage	$V_{GS}$	V	-3	-3	-3	-3	-3	-5
Total Power Dissipation	$P_T$	mW	100	100	200	100	300	3W (*)
Channel Temperature	$T_{CH}$	°C	150	150	150	150	150	150
Storage Temperature	$T_{stg}$	°C	-45 ~ 125	-45 ~ 125	-45 ~ 125	-45 ~ 125	-45 ~ 125	-45 ~ 125
Drain Current	$I_D$	mA	60	60	180	60	360	2000

(\*) On infinite heatsink

### (KGL2115 Prescaler)

Parameter	Symbol	Unit	Rating
Supply Voltage	$V_{DD}$	V	-0.5 ~ 7.0
MC Input Voltage	$V_{MC}$	V	-0.5 ~ VDD
CLK Input Voltage	$V_{IN}$	V	-1.5 ~ 1.5
Operating Temperature	$T_{opt}$	°C	-30 ~ 85
Storage Temperature	$T_{stg}$	°C	-55 ~ 125

**ELECTRICAL CHARACTERISTICS**  
(Analog Devices)

Parameter	Symbol	Unit	KGF1145	KGF1155	KGF1165	KGF1175	KGF1255	KGA1301
Gate Source Leak Current	$I_{GSS}$	$\mu A$	~12	~12	~40	~12	~72	~300
Gate Drain Leak Current	$I_{DGO}$	$\mu A$	~60	~60	~200	~60	~360	~1000
Drain Source Leak Current	$I_{DsoFF}$	$\mu A$	~120	~120	~400	~120	~720	~1000
Drain Current	$I_{DSS}$	mA	15~	15~	40~	15~	130~	1270~
Gate Source Cut off Voltage	$V_{GsoFF}$	V	-2.0 ~ -1.0	-2.0 ~ -1.0	-1.5 ~ -0.5	-2.0 ~ -1.0	-2.0 ~ -1.0	-3.5 ~ -2.5
Operating Current	$I_D$	mA	~4	~2.5	~25	~2.5	~80	~400
Noise Figure	F	dB	~3	~3	~4	~2	~2.5	—
Output Power	$P_O$	dBm	2~	3~	7~	3~	17~	31.5~
Isolation	$I_{SO}$	dB	40~	—	—	—	—	—
Transconductance	$g_m$	mS	8~	8~	55~	8~	125~	~400
Linear Gain	$G_{LIN}$	dB	—	12~	7~	12~	—	—
Input Return Loss	$R_{LIN}$	dB	—	—	~10	—	—	—

(KGL2115 Prescaler)

Parameter	Symbol	Unit	Specification
Power Supply Current	$I_{DD}$	mA	~6.0
Output Voltage	$V_O$	Vp-p	0.5~4.5
Toggle Frequency	$f_{IN}$	GHz	0.7~1.0
CLK Input Voltage	$V_{IN}$	Vp-p	0.4~1.0
MC Input Voltage High	$V_{IH}$	V	2~ $V_{DD}$
MC Input Voltage Low	$V_{IL}$	V	0~0.8
MC Input Current High	$I_{IH}$	mA	~0.15

( $T_a = -30 \sim 85^\circ C$ )

**ANALOG DEVICE**  
**CIRCUIT AND PIN ASSIGNMENT**

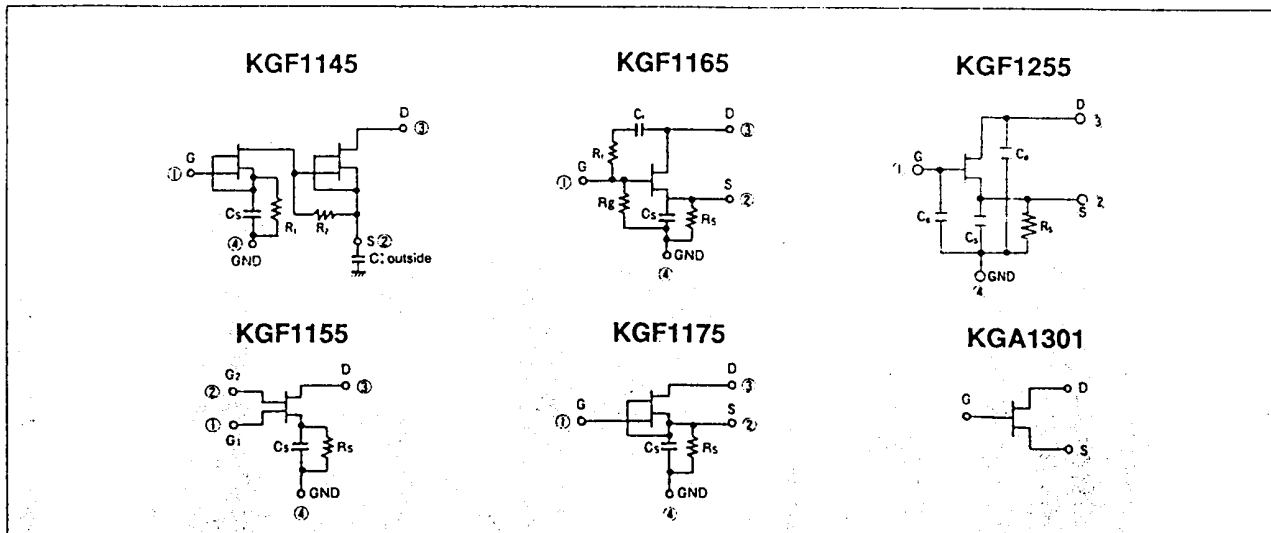

**PIN ASSIGNMENT AND PACKAGE DRAWING**  
(Analog Device)

Type	1	2	3	4	Remarks
KGF1145	Gate	Source	Drain	GND	Self bias only
KGF1155	1 Gate	2 Gate	Drain	GND	Self bias only
KGF1165	Gate	Source	Drain	GND	④ Self bias ② Non Self bias
KGF1175	Gate	Source	Drain	GND	④ Self bias ② Non Self bias
KGF1255	Gate	Source	Drain	GND	④ Self bias ② Non Self bias

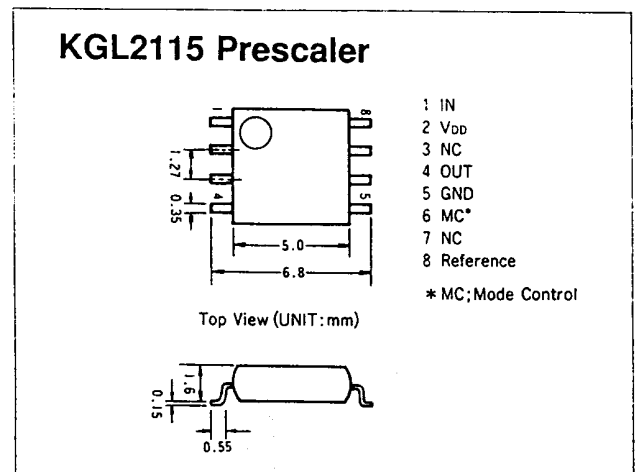
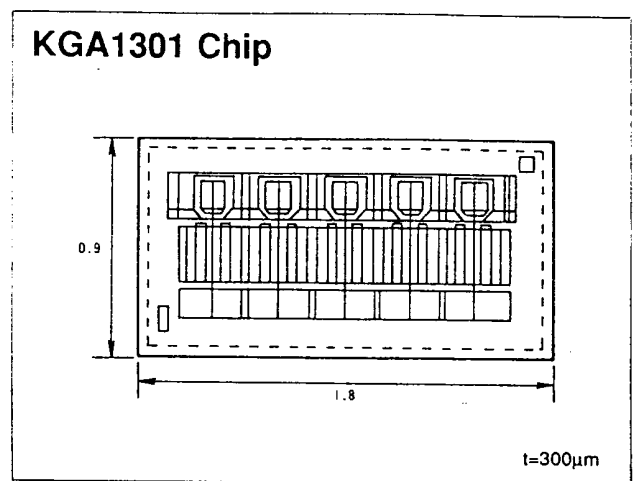
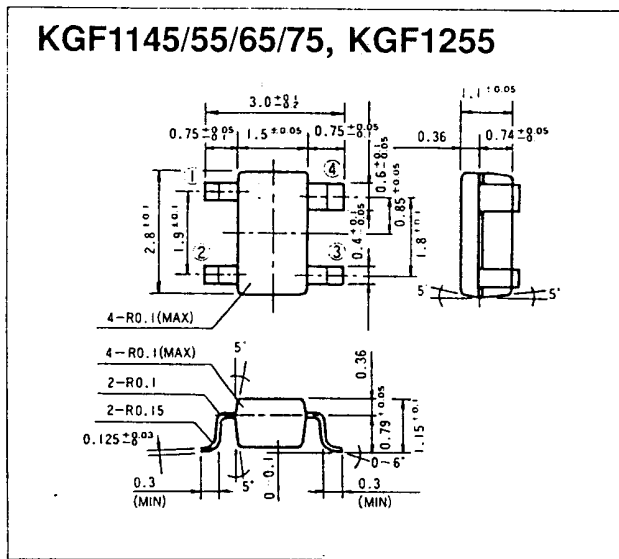

All specifications and details published are subject to change without notice

## **OkI Regional Sales Offices**

### **Northwest Area**

360 Kiely Blvd.  
Suite 115  
San Jose, CA 95129  
Tel: 408-244-9666  
Fax: 408-244-8423

### **Southwest Area**

2302 Martin St.  
Suite 250  
Irvine, CA 92715  
Tel: 714-752-1843  
Fax: 714-752-2423

5530 Corbin Avenue  
Suite 355  
Tarzana, CA 91356  
Tel: 818-774-9091  
Fax: 818-774-0189

### **Central Area**

Three Crossroads  
of Commerce  
Suite 590  
Rolling Meadows, IL 60008  
Tel: 708-870-1400  
Fax: 708-870-1659

2007 N. Collins Blvd.  
Suite 303  
Richardson, TX 75080  
Tel: 214-690-6868  
Fax: 214-690-8233

### **Automotive Electronics**

17177 N. Laurel Park Dr.  
Livonia, MI 48152  
Tel: 313-464-7200  
Fax: 313-464-1724

### **Southeast Area**

7301 W. Palmetto Park Rd.  
Suite 205C  
Boca Raton, FL 33433  
Tel: 407-394-6099  
Fax: 407-395-2716

5672 Peachtree Pkwy.  
Suite F  
Norcross, GA 30092  
Tel: 404-448-7111  
Fax: 404-447-1630

### **Eastern Area**

91 Montvale Ave.  
Stoneham, MA 02180  
Tel: 617-279-0293  
Fax: 617-438-3608

440 Lakeside Dr.  
Horsham, PA 19044  
Tel: 215-674-9511  
Fax: 215-674-1861

205 South Avenue  
Suite 100  
Poughkeepsie, NY 12601  
Tel: 914-473-8044  
Fax: 914-473-7069



**OKI**  
Semiconductor

785 North Mary Avenue  
Sunnyvale, California 94086-2909  
Tel: 408-720-1900  
Fax: 408-720-1918

OKI Semiconductor reserves the right to make changes in specifications at any time and without notice. The information furnished by OKI Semiconductor in this publication is believed to be accurate and reliable. However, no responsibility is assumed by OKI Semiconductor for its use; nor for any infringements of patents or other rights of third parties resulting from its use. No license is granted under any patents or patent rights of OKI.