

High Power PIN Diodes

V9

Features

- ◆ High Power Handling
- ◆ Low Loss / Low Distortion
- ◆ Voltage Ratings up to 1000 Volts
- ◆ Passivated Chip for Low Leakage Current
- ◆ Low Theta (θ) Due to Full Face Chip Bonding
- ◆ Leadless Low Inductance MELF Packages
- ◆ Various Package Options
- ◆ Available as Chips
- ◆ Fully RoHS Compliant

Description

M/A-COM Technology Solutions MELF and HIPAX PIN diode series are designed for usage in switch and attenuator applications requiring high power handling and low distortion. The MELF and HIPAX PIN diodes incorporate a fully passivated PIN diode chip resulting in an extremely low reverse bias leakage current. The semiconductor technology utilized in the MELF and HIPAX families draws on M/A-COM's substantial experience in PIN diode design and wafer fabrication. The result is a device which has a thick I-region and long carrier lifetime while maintaining low series resistance and capacitance values. The chips of the MELF and HIPAX PIN diodes are enclosed in a rugged ceramic package and is full face bonded to metal pins on both the anode and cathode. The result is a low loss PIN diode with low thermal resistance due to symmetrical thermal paths. The parts are offered in either a HIPAX, axial leaded or **Metal Electrode Leadless Faced (MELF)** surface mount packages that have a rectangular outline. These rectangular SMQ, PIN diodes are designed for high volume tape and reel assembly. This easy to use package design makes automatic pick and place, indexing and assembly, extremely easy. The parallel flat surfaces are suitable for most key jaw or vacuum pick-up techniques. All solderable surfaces are tin plated and compatible with industry standard reflow and vapor phase soldering processes.

Package Styles



401 & 402

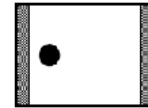

1072 & 1091

Applications

HIPAX PIN diodes are designed for use in a wide variety of switch and attenuator applications from HF through UHF frequencies and at power levels above 1kW, CW. The internal chip as well as each diode assembly has been comprehensively tested and characterized to ensure predictable and repeatable performance.

Design Recommendations

- ◆ Low Distortion Attenuators
 - MA4P4301B
- ◆ Surface Mount Switches
 - MA4P7101F
- ◆ Cellular Radio Antenna Switches
 - MA4P1200, MA4P1250

Absolute Maximum Ratings

$T_{AMB} = +25^{\circ}\text{C}$ (Unless Otherwise Noted) ^{1,2}

Parameter	Absolute Maximum
D.C. Reverse Voltage	(See Tables)
Operating Chip Junction Temperature	-55°C to +175°C
Storage Temperature	-55°C to +200°C
Installation Temperature	+280°C for 30 Seconds

Notes

1. Operation of this device above any one of these parameters may cause permanent damage.
2. Please refer to application note [M538](#) for surface mounting instructions.

1 **ADVANCED:** Data Sheets contain information regarding a product M/A-COM Technology Solutions is considering for development. Performance is based on target specifications, simulated results, and/or prototype measurements. Commitment to develop is not guaranteed.
PRELIMINARY: Data Sheets contain information regarding a product M/A-COM Technology Solutions has under development. Performance is based on engineering tests. Specifications are typical. Mechanical outline has been fixed. Engineering samples and/or test data may be available. Commitment to produce in volume is not guaranteed.

• **North America** Tel: 800.366.2266 • **Europe** Tel: +353.21.244.6400
 • **India** Tel: +91.80.4155721 • **China** Tel: +86.21.2407.1588
 Visit www.macomtech.com for additional data sheets and product information.

M/A-COM Technology Solutions Inc. and its affiliates reserve the right to make changes to the product(s) or information contained herein without notice.

High Power PIN Diodes

V9

MA4P1000 Series Electrical Specifications @ T_{AMB} = +25°C

Part Number	V _R Reverse Voltage V _{DC}		C _T Total Capacitance pF		R _S Series Resistance Ω		R _P Parallel Resistance kΩ	
	<u>Condition</u> I _R = 10 μA		<u>Conditions</u> f = 1 MHz V _R = 50 V		<u>Conditions</u> f = 100 MHz I _F = 50 mA		<u>Conditions</u> f = 100 MHz V _R = 0 V	
	MINIMUM	MAXIMUM RATING	TYPICAL	MAXIMUM	TYPICAL	MAXIMUM	MINIMUM	
MA4P1200 - 401T	50	100	1.2	1.5	0.5	0.75	5	
MA4P1250 - 1072T	50	100	0.8	1.2	0.5	0.75	5	
MA4P1450 - 1091T	50	100	1.8	2.5	0.5	0.75	5	

Part Number	V _F Forward Voltage		T _L Carrier Lifetime		Forward Bias Harmonic Distortion R(2a/a) * R(3a/a)		Reverse Bias Harmonic Distortion R(2a/a) – R(3a/a)	
	<u>Condition</u> I _F = 50 mA		<u>Conditions</u> I _F = 10 mA I _R = 6 mA		<u>Conditions</u> f = 100 MHz P _{IN} = 30 W		<u>Conditions</u> f = 100 MHz P _{IN} = 0 dBm	
	TYPICAL	MAXIMUM RATING ²	MINIMUM	TYPICAL	MINIMUM	TYPICAL	MINIMUM	TYPICAL
MA4P1200 - 401T ¹	0.85	1.0	2	8	80	90	60	70
MA4P1250 - 1072T ¹	0.85	1.0	2	8	80	90	60	70
MA4P1450 - 1091T ¹	0.85	1.0	2	8	80	90	60	70

* **Notes:** 1.) Also available in a non-magnetic package for MRI applications. Same electrical specifications as above.
 Non-magnetic version of the MA4P1200 - 401T = MA4P1200NM - 401T
 Non-magnetic version of the MA4P1250 - 1072T = MA4P1250NM - 1072T
 2.) Maximum forward current for all devices @ 1V is 1.5A

Power Dissipation and Thermal Resistance Ratings @ T_{AMB} = +25°C

Package Style	CONDITION	MA4P1200-401T		MA4P1250-1072T		MA4P1450-1091T	
		P _{DISS}	θ _{JC}	P _{DISS}	θ _{JC}	P _{DISS}	θ _{JC}
B Axial Lead	No Heatsink	1.5 W	15°C/W	—	—	—	—
	Lead Length 1/4"	5.5W		—	—	—	—
F MELF	No Heatsink			6W	15°C/W	10W	5°C/W
	Infinite Heatsink			18W		30W	

Specifications subject to change without notice

2 **ADVANCED:** Data Sheets contain information regarding a product M/A-COM Technology Solutions is considering for development. Performance is based on target specifications, simulated results, and/or prototype measurements. Commitment to develop is not guaranteed.
PRELIMINARY: Data Sheets contain information regarding a product M/A-COM Technology Solutions has under development. Performance is based on engineering tests. Specifications are typical. Mechanical outline has been fixed. Engineering samples and/or test data may be available. Commitment to produce in volume is not guaranteed.

• **North America** Tel: 800.366.2266 • **Europe** Tel: +353.21.244.6400
 • **India** Tel: +91.80.4155721 • **China** Tel: +86.21.2407.1588
 Visit www.macomtech.com for additional data sheets and product information.

M/A-COM Technology Solutions Inc. and its affiliates reserve the right to make changes to the product(s) or information contained herein without notice.

Typical Performance Curves @ $T_{AMB} = +25^{\circ}C$ MA4P1200 Series

Series Resistance @ 100 MHz vs. Forward Current

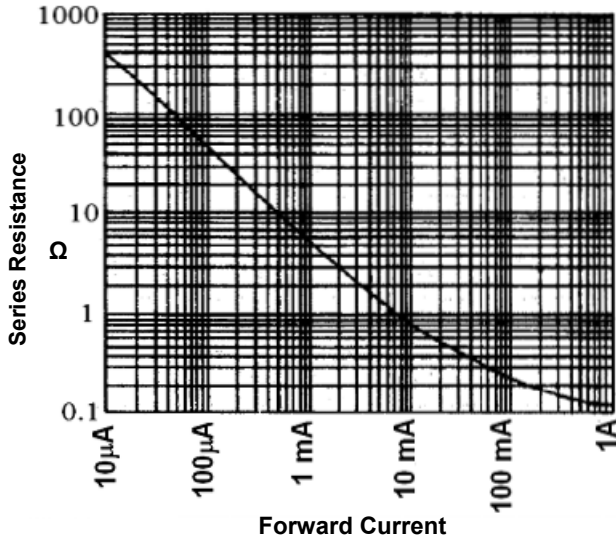

Capacitance vs. Frequency & Reverse Bias

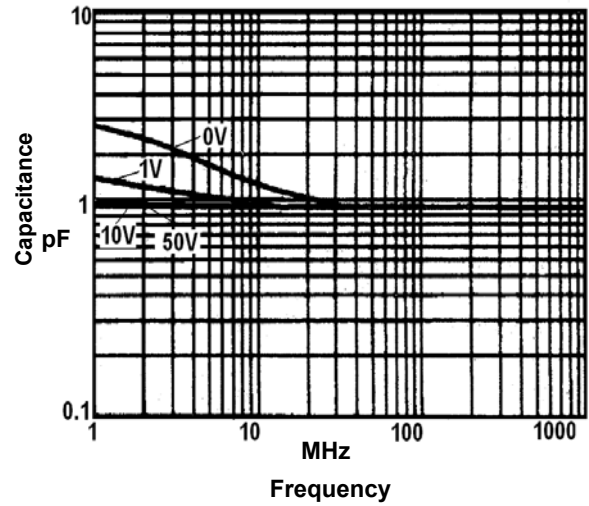

Parallel Resistance vs. Frequency & Reverse Bias

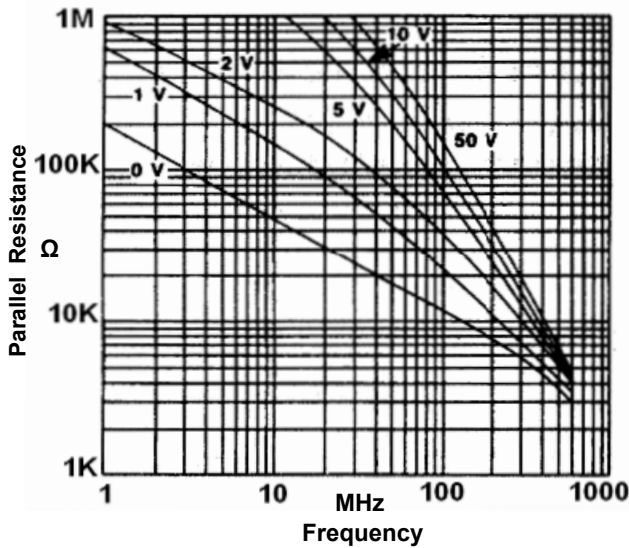

Heatsink Temperature vs. Max. Power Dissipation

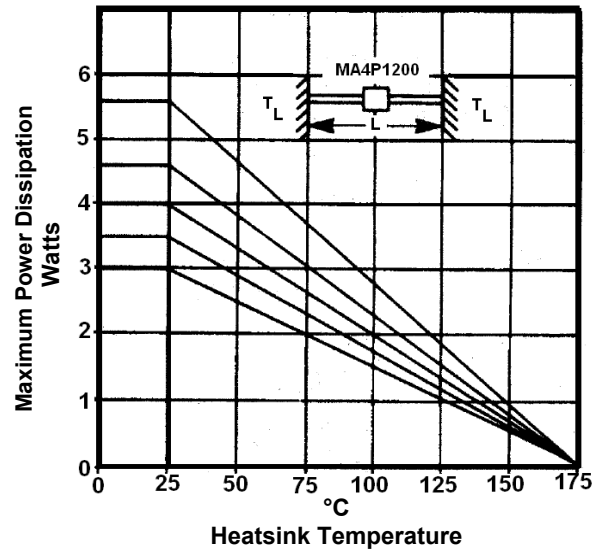

3 **ADVANCED:** Data Sheets contain information regarding a product M/A-COM Technology Solutions is considering for development. Performance is based on target specifications, simulated results, and/or prototype measurements. Commitment to develop is not guaranteed.
PRELIMINARY: Data Sheets contain information regarding a product M/A-COM Technology Solutions has under development. Performance is based on engineering tests. Specifications are typical. Mechanical outline has been fixed. Engineering samples and/or test data may be available. Commitment to produce in volume is not guaranteed.

• **North America** Tel: 800.366.2266 • **Europe** Tel: +353.21.244.6400
• **India** Tel: +91.80.4155721 • **China** Tel: +86.21.2407.1588
Visit www.macomtech.com for additional data sheets and product information.

M/A-COM Technology Solutions Inc. and its affiliates reserve the right to make changes to the product(s) or information contained herein without notice.

Typical Performance Curves @ $T_{AMB} = +25^{\circ}C$ MA4P1250 Series

Series Resistance @ 100 MHz vs. Forward Current

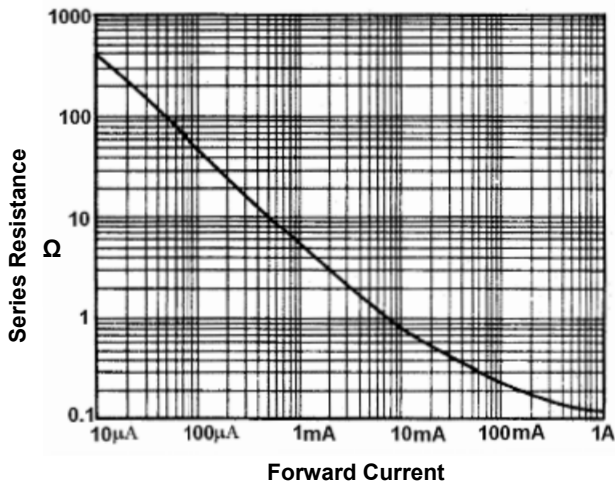

Capacitance vs. Frequency & Reverse Bias

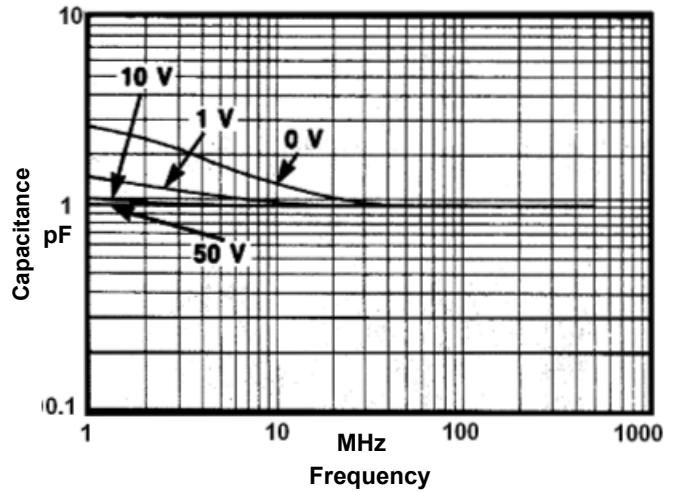

Parallel Resistance vs. Frequency & Reverse Bias

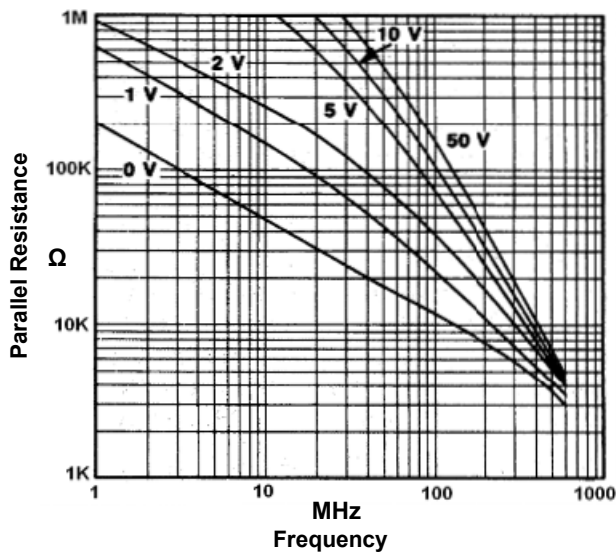

Carrier Lifetime vs. Forward Bias Current

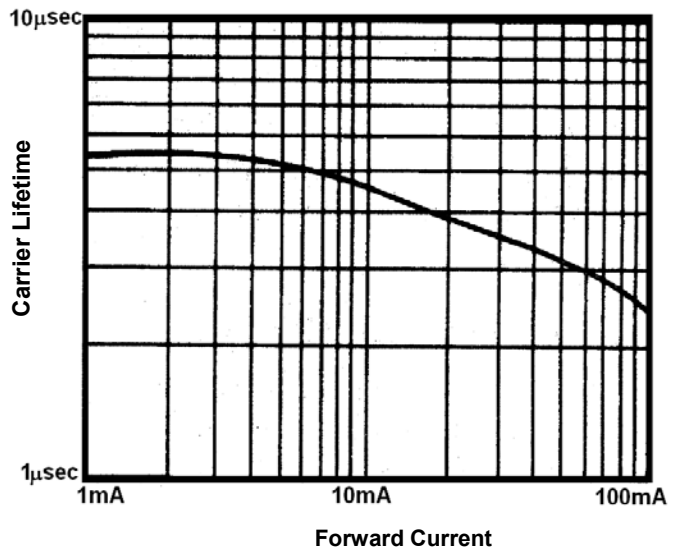

4 **ADVANCED:** Data Sheets contain information regarding a product M/A-COM Technology Solutions is considering for development. Performance is based on target specifications, simulated results, and/or prototype measurements. Commitment to develop is not guaranteed.
PRELIMINARY: Data Sheets contain information regarding a product M/A-COM Technology Solutions has under development. Performance is based on engineering tests. Specifications are typical. Mechanical outline has been fixed. Engineering samples and/or test data may be available. Commitment to produce in volume is not guaranteed.

• **North America** Tel: 800.366.2266 • **Europe** Tel: +353.21.244.6400
• **India** Tel: +91.80.4155721 • **China** Tel: +86.21.2407.1588
Visit www.macomtech.com for additional data sheets and product information.

M/A-COM Technology Solutions Inc. and its affiliates reserve the right to make changes to the product(s) or information contained herein without notice.

Typical Performance Curves @ $T_{AMB} = +25^{\circ}C$ MA4P1450 Series

Series Resistance @ 100 MHz vs. Forward Current

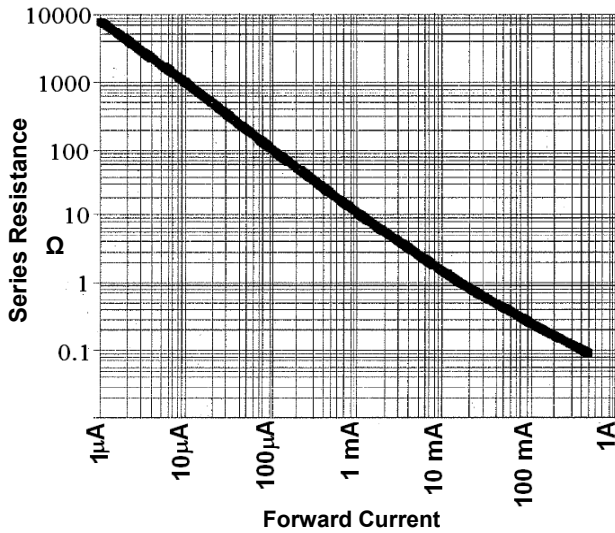

Capacitance vs. Frequency and Reverse Bias

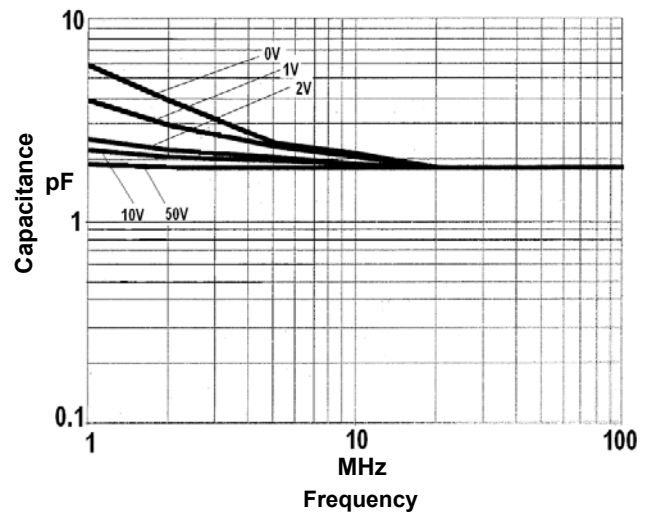

Parallel Resistance vs. Frequency and Reverse Bias

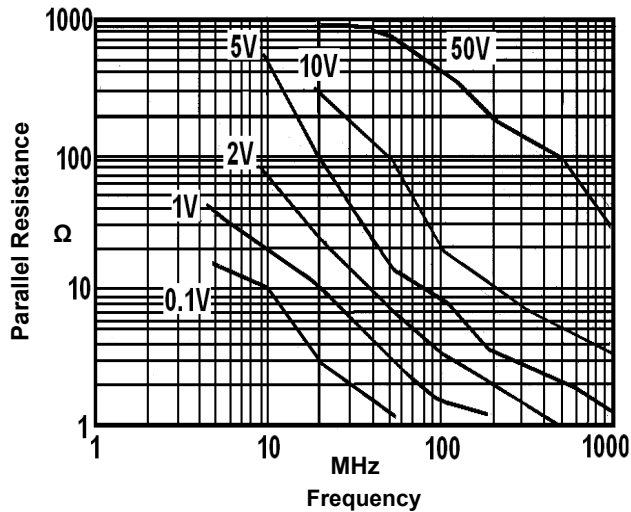

5 **ADVANCED:** Data Sheets contain information regarding a product M/A-COM Technology Solutions is considering for development. Performance is based on target specifications, simulated results, and/or prototype measurements. Commitment to develop is not guaranteed.
PRELIMINARY: Data Sheets contain information regarding a product M/A-COM Technology Solutions has under development. Performance is based on engineering tests. Specifications are typical. Mechanical outline has been fixed. Engineering samples and/or test data may be available. Commitment to produce in volume is not guaranteed.

• **North America** Tel: 800.366.2266 • **Europe** Tel: +353.21.244.6400
• **India** Tel: +91.80.4155721 • **China** Tel: +86.21.2407.1588
Visit www.macomtech.com for additional data sheets and product information.

M/A-COM Technology Solutions Inc. and its affiliates reserve the right to make changes to the product(s) or information contained herein without notice.

High Power PIN Diodes

V9

MA4P4000 - MA4P7000 Series Electrical Specifications @ $T_{AMB} = +25^{\circ}\text{C}$

Parameter	Symbol	Condition	MA4P4000 Series	MA4P4300 Series	MA4P7000 Series	MA4P7100 Series
Maximum Series Resistance	R_S	$I_F = 100\text{ mA}$ $f = 100\text{ MHz}$	0.5 Ω	1.0 Ω	0.9 Ω	0.5 Ω
Maximum Total Capacitance	C_T	$V_R = 100\text{ V}$ $f = 1\text{ MHz}$	2.2 pF	2.0 pF	0.7 pF	1.0 pF
Minimum Parallel Resistance	R_P	$V_R = 100\text{ V}$ $f = 100\text{ MHz}$	20 k Ω	50 k Ω	200 k Ω	100 k Ω
Minimum Carrier Lifetime	T_L	$I_F = 10\text{ mA}$ $I_R = 6\text{ mA}$	6 μs	8 μs	3 μs	2.5 μs
Maximum Forward Voltage	V_F	$I_F = 100\text{ mA}$	1.0 V	1.2 V	1.0 V	1.0 V
Maximum Reverse Current	I_R	At Maximum Rated Reverse Voltage	1 μA	1 μA	1 μA	1 μA
Nominal I-Region Width	μ	—	175 μm	300 μm	175 μm	100 μm

Maximum Rated Reverse Voltage (V_R) vs. Model Numbers

Maximum Rated Reverse	MA4P4000 Series	MA4P4300 Series	MA4P7000 Series	MA4P7100 Series
100 Volts	MA4P4001B-402 MA4P4001F-1091T	MA4P4301B-402 MA4P4301F-1091T	MA4P7001F-1072T	MA4P7101B-401/401T MA4P7101F-1072T
200 Volts	MA4P4002B-402 MA4P4002F-1091T	—	MA4P7002B-401T MA4P7002F-1072T	MA4P7102B-401/401T MA4P7102F-1072T
400 Volts	—	—	—	MA4P7104B-401/401T MA4P7104F-1072T
600 Volts	MA4P4006B-402 MA4P4006F-1091T	—	MA4P7006B-401T MA4P7006F-1072T	—

Power Dissipation and Thermal Resistance Ratings @ $T_{AMB} = +25^{\circ}\text{C}$

Package Style	Condition	MA4P4000 Series		MA4P4300 Series		MA4P7000 Series		MA4P7100 Series	
		P_{DISS}	θ_{JC}	P_{DISS}	θ_{JC}	P_{DISS}	θ_{JC}	P_{DISS}	θ_{JC}
B Axial Leaded	1/4" Lead Length	12 W	12.5°C/W	10 W	15°C/W	5 W	30°C/W	6 W	25°C/W
	No Heatsink	2.5 W	—	2.5 W	—	1.5 W	—	1.5 W	—
F MELF	Infinite Heatsink	7.5 W	20°C/W	5 W	30°C/W	3 W	50°C/W	3 W	50°C/W
Both B and F	Single 1 μs pulse	100 kW	—	100 kW	—	15 kW	—	15 kW	—
Both B and F	Single 100 μs pulse	5 kW	0.03°C/W	5 kW	0.03°C/W	300 W	0.5°C/W	300 W	0.5°C/W

*Specifications subject to change without notice

6 **ADVANCED:** Data Sheets contain information regarding a product M/A-COM Technology Solutions is considering for development. Performance is based on target specifications, simulated results, and/or prototype measurements. Commitment to develop is not guaranteed.
PRELIMINARY: Data Sheets contain information regarding a product M/A-COM Technology Solutions has under development. Performance is based on engineering tests. Specifications are typical. Mechanical outline has been fixed. Engineering samples and/or test data may be available. Commitment to produce in volume is not guaranteed.

• **North America** Tel: 800.366.2266 • **Europe** Tel: +353.21.244.6400
 • **India** Tel: +91.80.4155721 • **China** Tel: +86.21.2407.1588
 Visit www.macomtech.com for additional data sheets and product information.

M/A-COM Technology Solutions Inc. and its affiliates reserve the right to make changes to the product(s) or information contained herein without notice.

Typical Performance Curves @ $T_{AMB} = +25^{\circ}C$ MA4P4000, MA4P4300, MA4P7000, MA4P7100 Series

Series Resistance at 100 MHz vs. Forward Current
MA4P4000, MA4P4300 Series

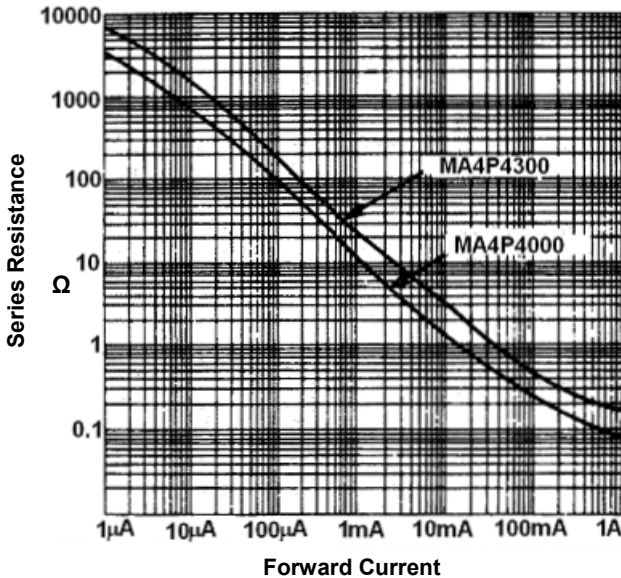

Series Resistance at 100 MHz vs. Forward Current
MA4P7000, MA4P7100 Series

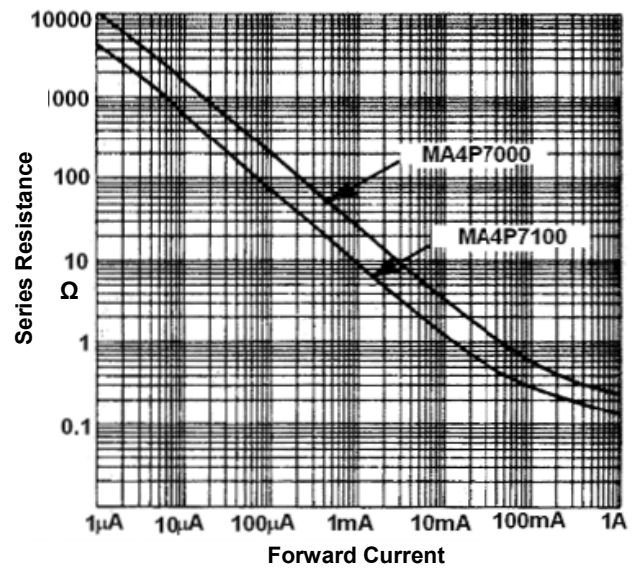

Thermal Resistance vs. Pulse Width
MA4P4000, MA4P4300, MA4P7000 & MA4P7100 Series

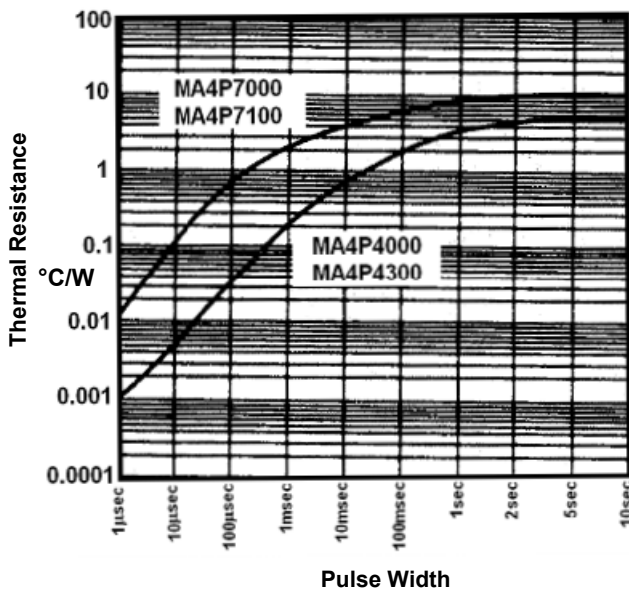

Carrier Lifetime vs. Forward Bias Current
MA4P4000, MA4P4300, MA4P7000 & MA4P7100 Series

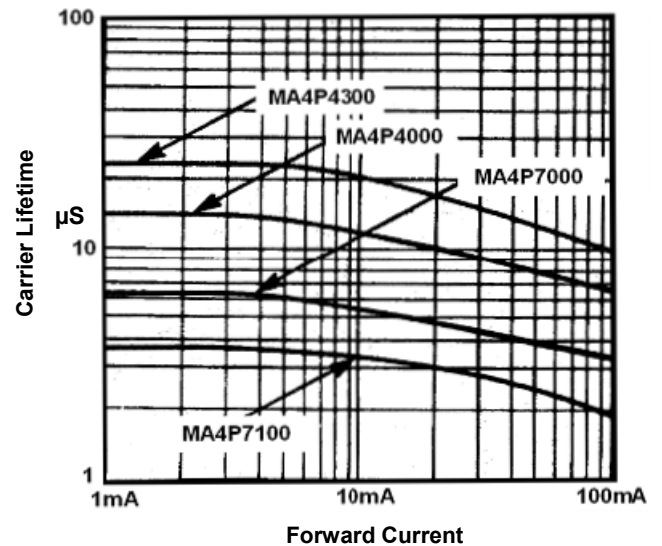

7 **ADVANCED:** Data Sheets contain information regarding a product M/A-COM Technology Solutions is considering for development. Performance is based on target specifications, simulated results, and/or prototype measurements. Commitment to develop is not guaranteed.
PRELIMINARY: Data Sheets contain information regarding a product M/A-COM Technology Solutions has under development. Performance is based on engineering tests. Specifications are typical. Mechanical outline has been fixed. Engineering samples and/or test data may be available. Commitment to produce in volume is not guaranteed.

• **North America** Tel: 800.366.2266 • **Europe** Tel: +353.21.244.6400
• **India** Tel: +91.80.4155721 • **China** Tel: +86.21.2407.1588
Visit www.macomtech.com for additional data sheets and product information.

M/A-COM Technology Solutions Inc. and its affiliates reserve the right to make changes to the product(s) or information contained herein without notice.

Typical Performance Curves @ $T_{AMB} = +25^{\circ}C$ MA4P4000, MA4P4300, MA4P7000, MA4P7100 Series

Capacitance vs. Frequency & Reverse Bias
MA4P4000 Series

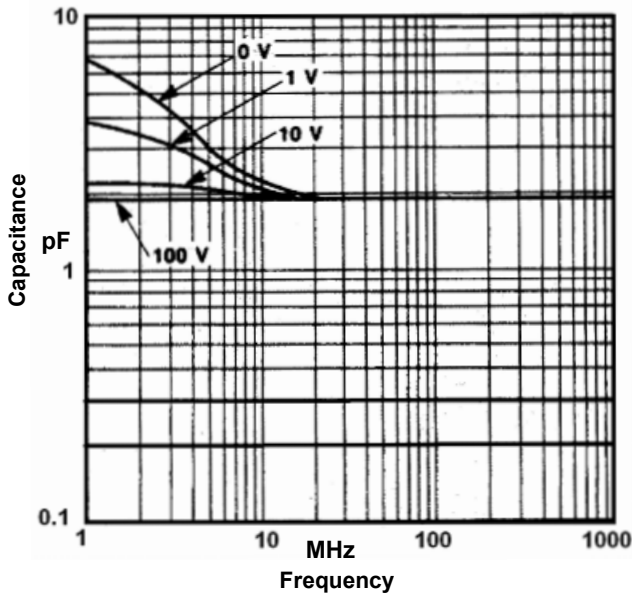

Capacitance vs. Frequency & Reverse Bias
MA4P4300 Series

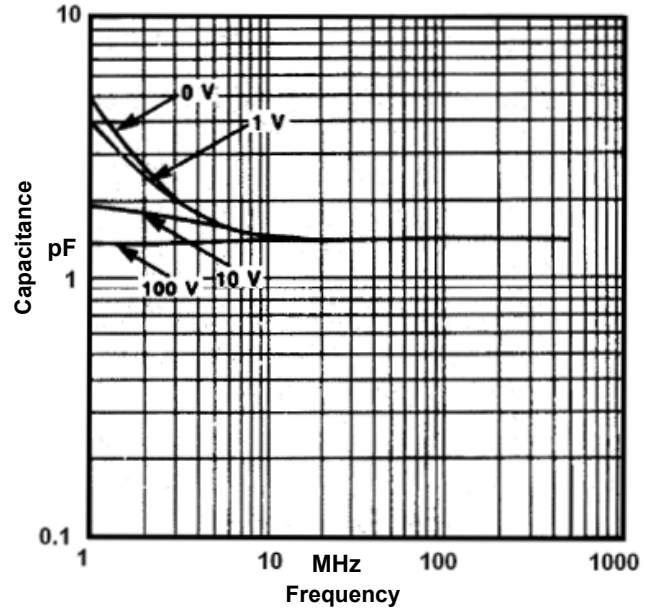

Capacitance vs. Frequency & Reverse Bias
MA4P7000 Series

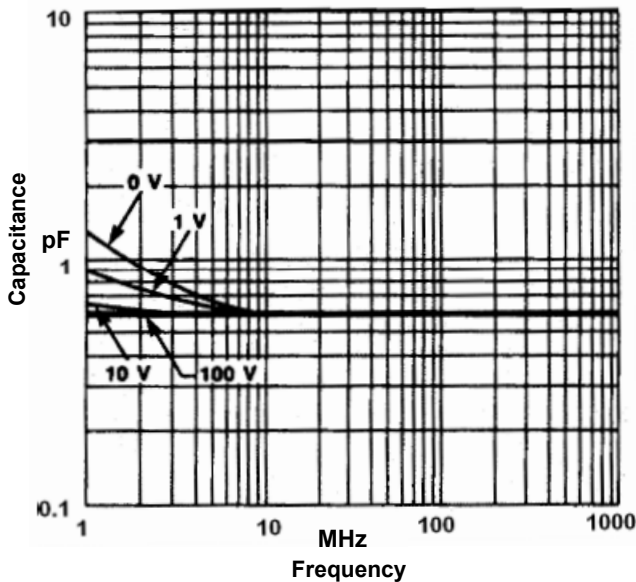

Capacitance vs. Frequency & Reverse Bias
MA4P7100 Series

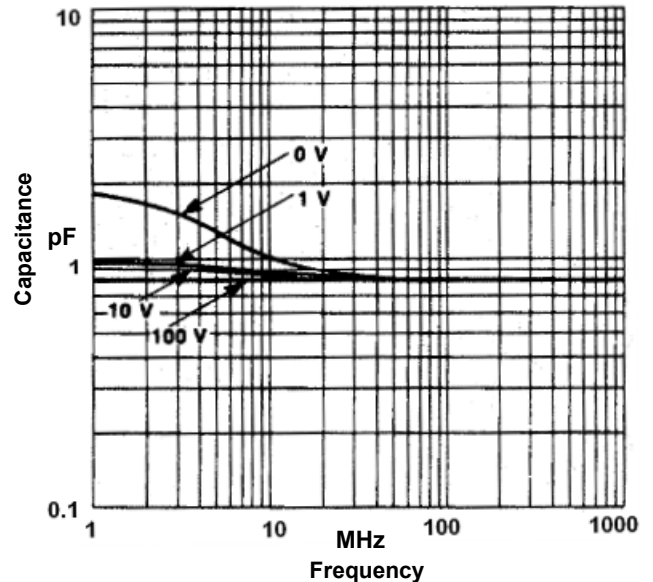

8 **ADVANCED:** Data Sheets contain information regarding a product M/A-COM Technology Solutions is considering for development. Performance is based on target specifications, simulated results, and/or prototype measurements. Commitment to develop is not guaranteed.
PRELIMINARY: Data Sheets contain information regarding a product M/A-COM Technology Solutions has under development. Performance is based on engineering tests. Specifications are typical. Mechanical outline has been fixed. Engineering samples and/or test data may be available. Commitment to produce in volume is not guaranteed.

• **North America** Tel: 800.366.2266 • **Europe** Tel: +353.21.244.6400
• **India** Tel: +91.80.4155721 • **China** Tel: +86.21.2407.1588
Visit www.macomtech.com for additional data sheets and product information.

M/A-COM Technology Solutions Inc. and its affiliates reserve the right to make changes to the product(s) or information contained herein without notice.

Typical Performance Curves @ $T_{AMB} = +25^{\circ}C$ MA4P4000, MA4P4300, MA4P7000, MA4P7100 Series

Parallel Resistance vs. Reverse Bias & Frequency
MA4P4000 Series

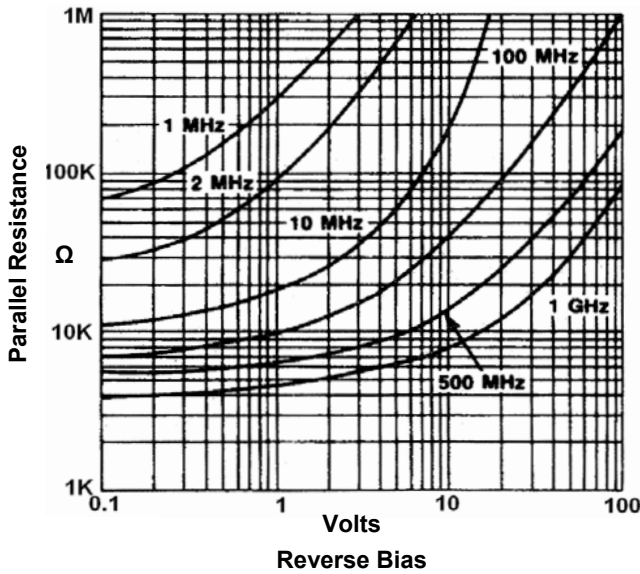

Parallel Resistance vs. Reverse Bias & Frequency
MA4P4300 Series

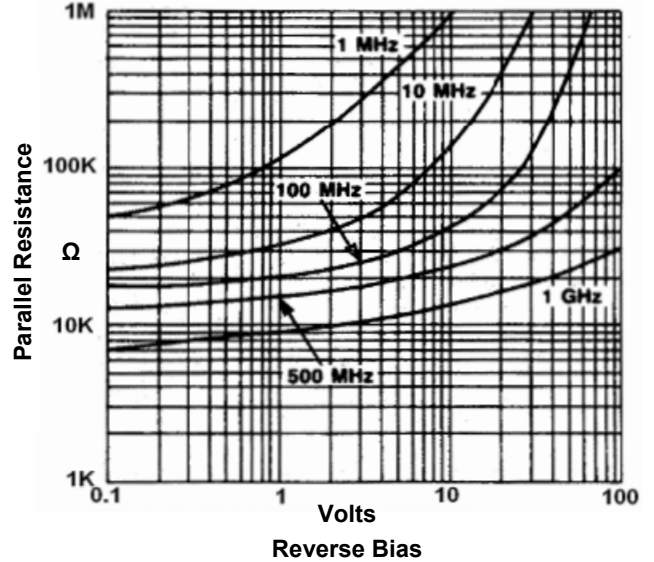

Parallel Resistance vs. Reverse Bias & Frequency
MA4P7000 Series

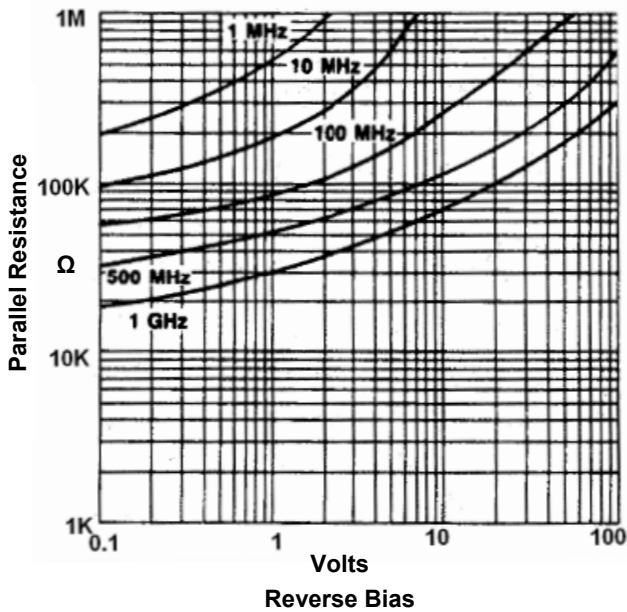

Parallel Resistance vs. Reverse Bias & Frequency
MA4P7100 Series

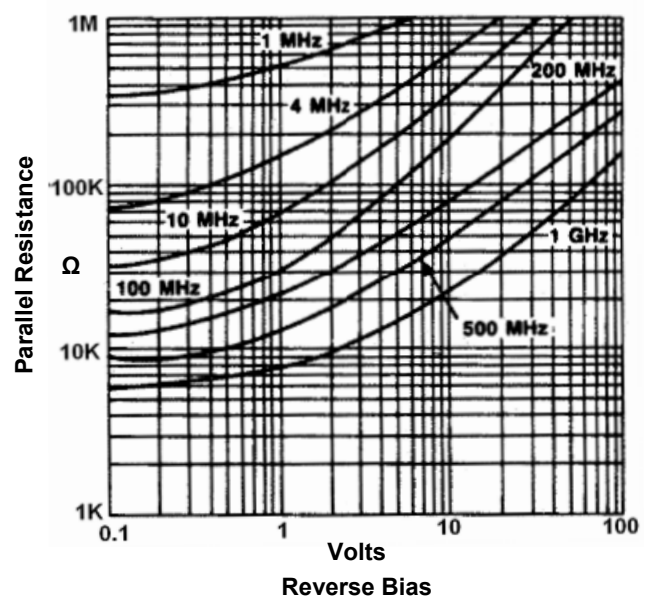

9 **ADVANCED:** Data Sheets contain information regarding a product M/A-COM Technology Solutions is considering for development. Performance is based on target specifications, simulated results, and/or prototype measurements. Commitment to develop is not guaranteed.
PRELIMINARY: Data Sheets contain information regarding a product M/A-COM Technology Solutions has under development. Performance is based on engineering tests. Specifications are typical. Mechanical outline has been fixed. Engineering samples and/or test data may be available. Commitment to produce in volume is not guaranteed.

• **North America** Tel: 800.366.2266 • **Europe** Tel: +353.21.244.6400
• **India** Tel: +91.80.4155721 • **China** Tel: +86.21.2407.1588
Visit www.macomtech.com for additional data sheets and product information.

M/A-COM Technology Solutions Inc. and its affiliates reserve the right to make changes to the product(s) or information contained herein without notice.

High Power PIN Diodes

V9

Case Styles

401 Axial Leaded Packages

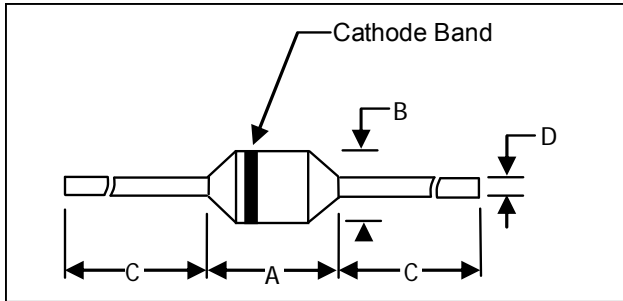

Parts Available in 401 Package (tape and reel)	Dimension	INCHES		MM	
		MIN.	MAX.	MIN.	MAX.
MA4P7002B-401T	A	—	0.130	—	3.30
MA4P7006B-401T	B	—	0.090	—	2.29
MA4P7101B-401T	C	0.975		24.77	—
MA4P7102B-401T					
MA4P7104B-401T	D	0.027	0.029	0.69	0.74

402 Axial Leaded Packages

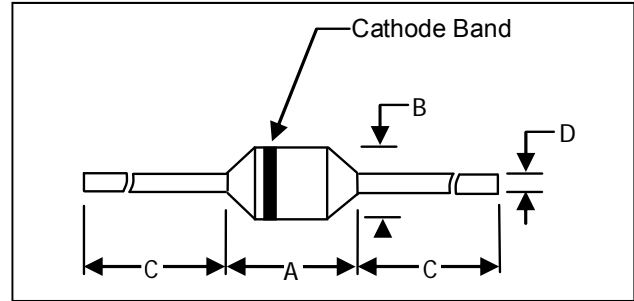

Parts Available in 402 Package (bulk only)	Dimension	INCHES		MM	
		MIN.	MAX.	MIN.	MAX.
MA4P4001B-402	A	—	0.230	—	5.84
	B	—	0.140	—	3.56
MA4P4002B-402	C	0.975		24.64	—
MA4P4006B-402					
MA4P4301B-402	D	0.039	0.041	0.76	1.02

1091 MELF Surface Mount Packages

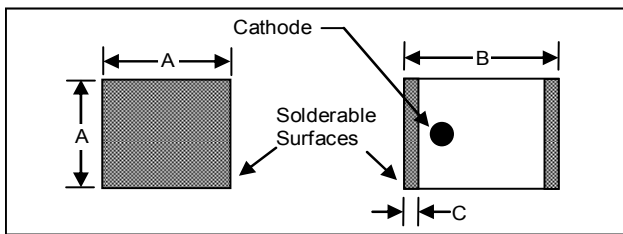

Parts Available in 1091 Package (tape and reel only)	Dimension	INCHES		MM	
		MIN.	MAX.	MIN.	MAX.
MA4P4001F-1091T	A	0.138	0.155	3.51	3.94
MA4P4002F-1091T	B	0.180	0.200	4.57	5.08
MA4P4006F-1091T					
MA4P4301F-1091T	C	0.008	0.030	0.203	0.762

1072 MELF Surface Mount Packages

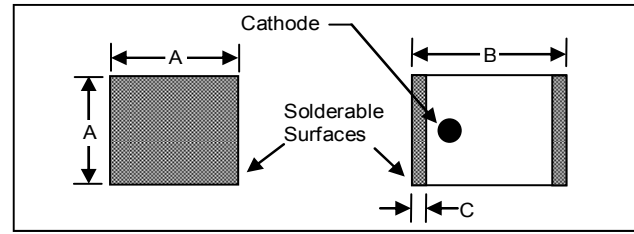

Parts Available in 1072 Package (tape and reel only)	Dimension	INCHES		MM	
		MIN.	MAX.	MIN.	MAX.
MA4P7001F-1072T	A	0.080	0.095	2.032	2.413
MA4P7002F-1072T					
MA4P7006F-1072T	B	0.115	0.135	2.921	3.429
MA4P7101F-1072T	C	0.008	0.030	0.203	0.762
MA4P7104F-1072T					

*Specifications subject to change without notice

10 **ADVANCED:** Data Sheets contain information regarding a product M/A-COM Technology Solutions is considering for development. Performance is based on target specifications, simulated results, and/or prototype measurements. Commitment to develop is not guaranteed.
PRELIMINARY: Data Sheets contain information regarding a product M/A-COM Technology Solutions has under development. Performance is based on engineering tests. Specifications are typical. Mechanical outline has been fixed. Engineering samples and/or test data may be available. Commitment to produce in volume is not guaranteed.

• **North America** Tel: 800.366.2266 • **Europe** Tel: +353.21.244.6400
 • **India** Tel: +91.80.4155721 • **China** Tel: +86.21.2407.1588
 Visit www.macomtech.com for additional data sheets and product information.

M/A-COM Technology Solutions Inc. and its affiliates reserve the right to make changes to the product(s) or information contained herein without notice.

High Power PIN Diodes

V9

MELF Assembly Recommendations

- ◆ Devices may be soldered using standard 60Sn/40Pb or RoHS compliant solders. Axial leads and solderable surfaces of MELF devices are tin plated 50 μM thick to ensure an optimum connection.
- ◆ For recommended Sn/Pb and RoHS soldering profiles See Application Note [M538](#) on the M/A-COM website.

Circuit Pad Layout for MELF Diodes

Dimension	Package Style 1072		Package Style 1091	
	inches	mm	inches	mm
A	0.093	2.36	0.150	3.81
B	0.050	1.27	0.050	1.27
C	0.060	1.52	0.100	2.54

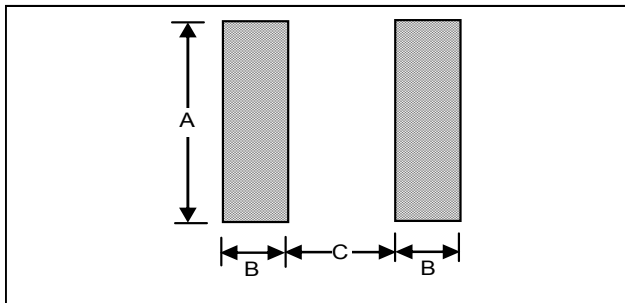

MELF Internal Construction

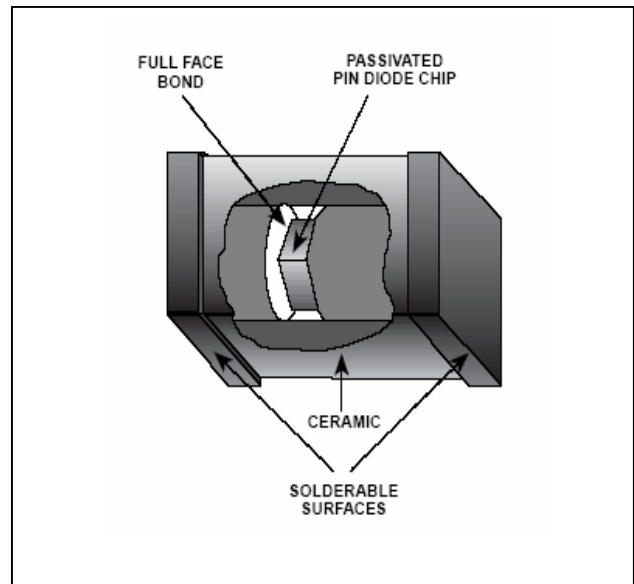

Ordering Information

MELF diodes are available in tape and reel in quantities as shown in table below

Package Style	Quantity 7" Reel	Bulk Devices Per Bag
1072T	1500	N/A
1091T	500	N/A

Tape and reel information can be found on the M/A-COM website [at http://www.macomtech.com/Application Notes/pdf/M513.pdf](http://www.macomtech.com/Application Notes/pdf/M513.pdf)

*Specifications subject to change without notice

11 **ADVANCED:** Data Sheets contain information regarding a product M/A-COM Technology Solutions is considering for development. Performance is based on target specifications, simulated results, and/or prototype measurements. Commitment to develop is not guaranteed.
PRELIMINARY: Data Sheets contain information regarding a product M/A-COM Technology Solutions has under development. Performance is based on engineering tests. Specifications are typical. Mechanical outline has been fixed. Engineering samples and/or test data may be available. Commitment to produce in volume is not guaranteed.

• **North America** Tel: 800.366.2266 • **Europe** Tel: +353.21.244.6400
 • **India** Tel: +91.80.4155721 • **China** Tel: +86.21.2407.1588
 Visit www.macomtech.com for additional data sheets and product information.

M/A-COM Technology Solutions Inc. and its affiliates reserve the right to make changes to the product(s) or information contained herein without notice.

High Power PIN Diodes

V9

Axial Leaded HIPAX Assembly Recommendations

- ◆ Bends on case styles 401 and 402, axially leaded devices, must be made while holding the lead firm and forming the bend no closer than .060 inches from the body of the part. Bending the lead < 0.060 inches from the body of the part is not recommended and may cause internal damage to the chip. Appropriate fixturing should be used.
- ◆ Devices may be soldered using standard 60Sn/40Pb or any RoHS compliant solders. Axial leads are tin plated 50µm thick to ensure an optimum connection.
- ◆ For recommended Sn/Pb and RoHS soldering profiles See Application Note [M538](#) on the M/A-COM website.

**Case Style 401 & 402
Minimum Bend Distance**

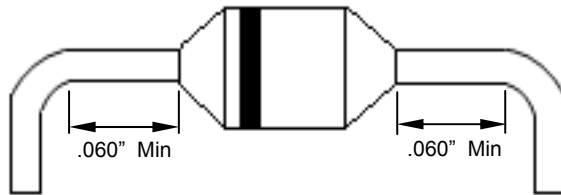

**Case Style 401 & 402
Internal Construction**

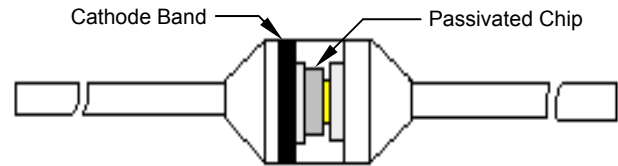

Ordering Information

Axial leaded diodes are available in tape and reel or bulk in quantities as shown in table below

Package Style	Quantity Per Reel	Bulk Devices Per Bag
401T	500	N/A
402	N/A	100

Environmental Ratings

HIPAX PIN diodes are designed to meet most environmental and electrical requirements and may be ordered screened to MIL-STD-750 specifications as described in the table below.

TEST	METHOD	DESCRIPTION/ CONDITIONS
Moisture Resistance	1021	85°C, 85% Relative Humidity, 168 hrs
High Temperature Storage	1031	+175°C , 250 Hours
HTRB	1038	80% of rated V _R , 50°C, 96 Hours
Temperature Shock	1051	-65°C to +175°C, 20 Cycles
Fine Leak	1071 Cond. H	1 X 10 ⁻⁷ CC/Sec
Constant Acceleration	2006	20,000 G's
Solderability	2026	IPC/JDEC J-STD-02
Tension ¹	2036.3 Cond. A	2 Lbs., 30 Seconds
Lead Fatigue ¹	2036.3 Cond. E	3 Cycles, 8 oz., 90°,

Note:

1. Test applicable to HIPAX axially leaded devices only.

12 ADVANCED: Data Sheets contain information regarding a product M/A-COM Technology Solutions is considering for development. Performance is based on target specifications, simulated results, and/or prototype measurements. Commitment to develop is not guaranteed.
PRELIMINARY: Data Sheets contain information regarding a product M/A-COM Technology Solutions has under development. Performance is based on engineering tests. Specifications are typical. Mechanical outline has been fixed. Engineering samples and/or test data may be available. Commitment to produce in volume is not guaranteed.

• **North America** Tel: 800.366.2266 • **Europe** Tel: +353.21.244.6400
 • **India** Tel: +91.80.4155721 • **China** Tel: +86.21.2407.1588
 Visit www.macomtech.com for additional data sheets and product information.

M/A-COM Technology Solutions Inc. and its affiliates reserve the right to make changes to the product(s) or information contained herein without notice.