

## High Voltage Positive Voltage Regulators

### GENERAL DESCRIPTION

The XC6202 series are highly precise, low power consumption, high voltage input, positive voltage regulators manufactured using CMOS and laser trimming technologies. The XC6202 consists of a current limiter circuit, a driver transistor, a precision reference voltage and an error correction circuit.

Output voltage is selectable in 100mV steps from 1.8V ~ 18V. The series are also compatible with low ESR ceramic capacitors which give added output stability.

Since the current limiter circuit is built-in, the IC is protected against overshoot currents at such times of output shorts etc. SOT-23 (150mW), SOT-89 (500mW), TO-92 (300mW), SOT-223 (1200mW) and USP-6B (100mW) packages are available.

### APPLICATIONS

- Battery powered equipment
- Reference voltage
- Cameras, video cameras
- Palmtops

### FEATURES

- Maximum Output Current** : 150mA (within Pd)
- Maximum Operational Voltage** : 20V
- Output Voltage Range** : 1.8V ~ 18V (0.1V increments)
- Highly Accurate** :  $\pm 2\%$
- Low Power Consumption** : 10  $\mu$  A (TYP.)
- Line Regulation** : 0.01% / V (TYP.)
- Dropout Voltage** : 200mV @ 30mA  
670mV @ 100mA
- Operational Temperature Range** : -40 ~ 85
- Low ESR Capacitor Compatible** : Ceramic capacitor
- Current Limiter Circuit Built-In**
- Small Packages** : SOT-23 (150mW),  
SOT-89 (500mW),  
TO-92 (300mW),  
SOT-223 (1200mW),  
USP-6B (100mW)

### TYPICAL APPLICATION CIRCUIT

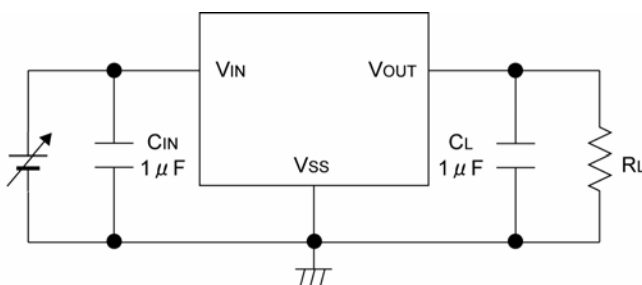

### TYPICAL PERFORMANCE CHARACTERISTICS

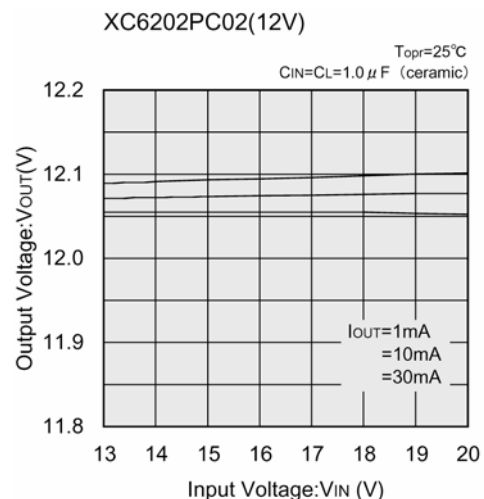

## PIN CONFIGURATION

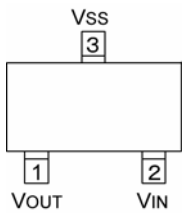

SOT-23  
(TOP VIEW)

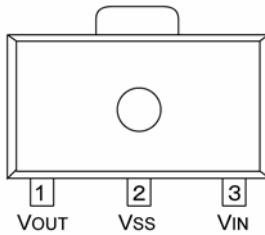

SOT-89  
(TOP VIEW)

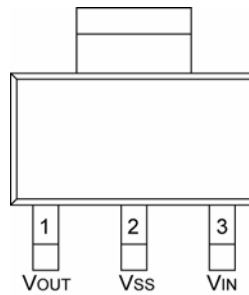

SOT-223  
(TOP VIEW)

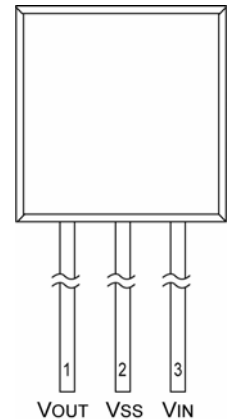

TO-92  
(TOP VIEW)

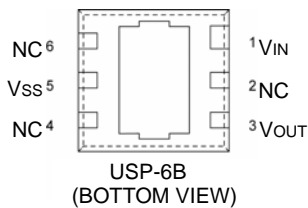

\*The dissipation pad for the USP-6B package should be solder-plated in recommended mount pattern and metal masking so as to enhance mounting strength and heat release. If the pad needs to be connected to other pins, it should be connected to the VSS (No.5) pin.

## PIN ASSIGNMENT

PIN NUMBER			PIN NAME	FUNCTION
SOT-23	SOT-89/TO-92/ SOT-223	USP-6B		
1	1	3	VOUT	Output
3	2	5	Vss	Ground
2	3	1	VIN	Power Input
-	-	2, 4, 6	NC	No connection

## PRODUCT CLASSIFICATION

Ordering Information

XC6202P \_\_\_\_\_

DESIGNATOR	DESCRIPTION	SYMBOL	DESCRIPTION
	Output Voltage	18 ~ J0	: For the voltage above 10V, see the example 10=A, 11=B 12=C, 13=D, 14=E, 15=F, 16=G, 17=H, 18=J e.g. VOUT= 3.0V :3, :0 VOUT= 12V :C, :0 VOUT= 15V :F, :0
	Accuracy	2	: ±2%
	Packages	M	: SOT-23
		P	: SOT-89
		T	: TO-92
		F	: SOT-223
		D	: USP-6B
	Device Orientation	R	: Embossed tape, standard feed
		L	: Embossed tape, reverse feed
		H	: Paper Tape (TO-92)
		B	: Bag (TO-92)

## BLOCK DIAGRAM

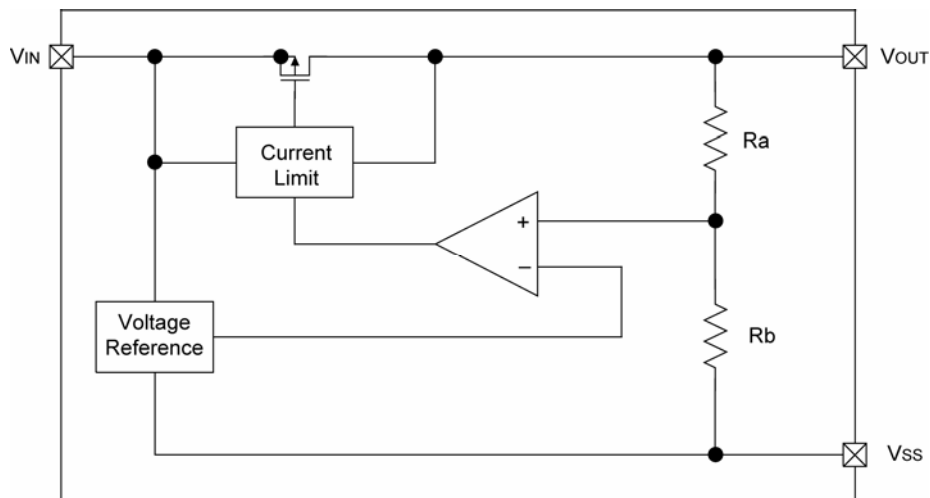

## ABSOLUTE MAXIMUM RATINGS

Ta = 25

PARAMETER	SYMBOL	RATINGS	UNITS
Input Voltage	V <sub>IN</sub>	22.0	V
Output Current	I <sub>OUT</sub>	500	mA
Output Voltage	V <sub>OUT</sub>	V <sub>SS</sub> -0.3 ~ V <sub>IN</sub> +0.3	V
Power Dissipation	SOT-25	150	mW
	SOT-89	500	
	TO-92	300	
	USP-6B	100	
	SOT-223	1,200*	
Operating Temperature Range	T <sub>opr</sub>	-40 ~ +85	
Storage Temperature Range	T <sub>stg</sub>	-55 ~ +125	

\* Circuits board mounting: Double-sided board

## ELECTRICAL CHARACTERISTICS

XC6202P182

$V_{OUT(T)}=1.8V$  <sup>(\*1)</sup>

Topr=25

PARAMETER	SYMBOL	CONDITIONS	MIN.	TYP.	MAX.	UNITS	CIRCUIT
Output Voltage	$V_{OUT(E)}$ <sup>(*2)</sup>	$V_{IN}=2.8V$ $I_{OUT}=30mA$	1.764	1.800	1.836	V	
Maximum Output Current	$I_{OUTmax}$	$V_{IN}=2.8V$ $V_{OUT} \leq V_{OUT(E)} \times 0.9$	60	-	-	mA	
Load Regulation	$V_{OUT}$	$V_{IN}=2.8V$ $1mA \leq I_{OUT} \leq 60mA$	-	10	80	mV	
Dropout Voltage <sup>(*3)</sup>	$V_{dif1}$	$I_{OUT}=30mA$	-	340	470	mV	
	$V_{dif2}$	$I_{OUT}=100mA$	-	1000	1500		
Supply Current	$I_{SS}$	$V_{IN}=2.8V$	-	10	24	$\mu A$	
Line Regulation	$\frac{V_{OUT}}{V_{IN}} \cdot \frac{V_{OUT}}{V_{OUT}}$	$I_{OUT}=1mA$ $2.8V \leq V_{IN} \leq 20V$	-	0.01	0.20	%/V	
Input Voltage	$V_{IN}$		-	-	20	V	-
Output Voltage Temperature Characteristics	$\frac{V_{OUT}}{Topr} \cdot \frac{V_{OUT}}{V_{OUT}}$	$I_{OUT}=30mA$ $-40 \leq Topr \leq 85$	-	$\pm 100$	-	ppm/	
Short-circuit Current	$I_{short}$	$V_{IN}=3.8V$	-	40	-	mA	

XC6202P332

$V_{OUT(T)}=3.3V$  <sup>(\*1)</sup>

Topr=25

PARAMETER	SYMBOL	CONDITIONS	MIN.	TYP.	MAX.	UNITS	CIRCUIT
Output Voltage	$V_{OUT(E)}$ <sup>(*2)</sup>	$V_{IN}=4.3V$ $I_{OUT}=30mA$	3.234	3.300	3.366	V	
Maximum Output Current	$I_{OUTmax}$	$V_{IN}=4.3V$ $V_{OUT} \leq V_{OUT(E)} \times 0.9$	150	-	-	mA	
Load Regulation	$V_{OUT}$	$V_{IN}=4.3V$ $1mA \leq I_{OUT} \leq 100mA$	-	25	90	mV	
Dropout Voltage <sup>(*3)</sup>	$V_{dif1}$	$I_{OUT}=30mA$	-	200	280	mV	
	$V_{dif2}$	$I_{OUT}=100mA$	-	670	900		
Supply Current	$I_{SS}$	$V_{IN}=4.3V$	-	10	24	$\mu A$	
Line Regulation	$\frac{V_{OUT}}{V_{IN}} \cdot \frac{V_{OUT}}{V_{OUT}}$	$I_{OUT}=1mA$ $4.3V \leq V_{IN} \leq 20V$	-	0.01	0.20	%/V	
Input Voltage	$V_{IN}$		-	-	20	V	-
Output Voltage Temperature Characteristics	$\frac{V_{OUT}}{Topr} \cdot \frac{V_{OUT}}{V_{OUT}}$	$I_{OUT}=30mA$ $-40 \leq Topr \leq 85$	-	$\pm 100$	-	ppm/	
Short-circuit Current	$I_{short}$	$V_{IN}=5.3V$	-	40	-	mA	

## ELECTRICAL CHARACTERISTICS (Continued)

XC6202P502

$V_{OUT(T)}=5.0V$  <sup>(\*)</sup>

Topr=25

PARAMETER	SYMBOL	CONDITIONS	MIN.	TYP.	MAX.	UNITS	CIRCUIT
Output Voltage	$V_{OUT(E)}$ <sup>(2)</sup>	$V_{IN}=6V$ $I_{OUT}=30mA$	4.900	5.000	5100	V	
Maximum Output Current	$I_{OUTmax}$	$V_{IN}=6V$ $V_{OUT} \leq V_{OUT(E)} \times 0.9$	200	-	-	mA	
Load Regulation	$V_{OUT}$	$V_{IN}=6V$ $1mA \leq I_{OUT} \leq 100mA$	-	30	100	mV	
Dropout Voltage <sup>(3)</sup>	$V_{dif1}$	$I_{OUT}=30mA$	-	130	190	mV	
	$V_{dif2}$	$I_{OUT}=100mA$	-	440	550		
Supply Current	$I_{SS}$	$V_{IN}=6V$	-	10	24	$\mu A$	
Line Regulation	$\frac{V_{OUT}}{V_{IN} \cdot V_{OUT}}$	$I_{OUT}=1mA$ $6V \leq V_{IN} \leq 20V$	-	0.01	0.20	%/V	
Input Voltage	$V_{IN}$		-	-	20	V	-
Output Voltage Temperature Characteristics	$\frac{V_{OUT}}{Topr \cdot V_{OUT}}$	$I_{OUT}=30mA$ $-40 \leq Topr \leq 85$	-	$\pm 100$	-	ppm/	
Short-circuit Current	$I_{short}$	$V_{IN}=7V$	-	40	-	mA	

XC6202PC02

$V_{OUT(T)}=12V$  <sup>(\*)</sup>

Topr=25

PARAMETER	SYMBOL	CONDITIONS	MIN.	TYP.	MAX.	UNITS	CIRCUIT
Output Voltage	$V_{OUT(E)}$ <sup>(2)</sup>	$V_{IN}=13V$ $I_{OUT}=30mA$	11.760	12.000	12.240	V	
Maximum Output Current	$I_{OUTmax}$	$V_{IN}=13V$ $V_{OUT} \leq V_{OUT(E)} \times 0.9$	200	-	-	mA	
Load Regulation	$V_{OUT}$	$V_{IN}=13V$ $1mA \leq I_{OUT} \leq 100mA$	-	60	230	mV	
Dropout Voltage <sup>(3)</sup>	$V_{dif1}$	$I_{OUT}=30mA$	-	90	150	mV	
	$V_{dif2}$	$I_{OUT}=100mA$	-	290	380		
Supply Current	$I_{SS}$	$V_{IN}=13V$	-	12	28	$\mu A$	
Line Regulation	$\frac{V_{OUT}}{V_{IN} \cdot V_{OUT}}$	$I_{OUT}=1mA$ $13V \leq V_{IN} \leq 20V$	-	0.01	0.20	%/V	
Input Voltage	$V_{IN}$		-	-	20	V	-
Output Voltage Temperature Characteristics	$\frac{V_{OUT}}{Topr \cdot V_{OUT}}$	$I_{OUT}=30mA$ $-40 \leq Topr \leq 85$	-	$\pm 100$	-	ppm/	
Short-circuit Current	$I_{short}$	$V_{IN}=14V$	-	40	-	mA	

## ELECTRICAL CHARACTERISTICS (Continued)

XC6202PJ02

$V_{OUT(T)}=18V$  <sup>(\*1)</sup>

$T_{opr}=25$

PARAMETER	SYMBOL	CONDITIONS	MIN.	TYP.	MAX.	UNITS	CIRCUIT
Output Voltage	$V_{OUT(E)}$ <sup>(*2)</sup>	$V_{IN}=19V$ $I_{OUT}=30mA$	17.640	18.000	18.360	V	
Maximum Output Current	$I_{OUTmax}$	$V_{IN}=19V$ $V_{OUT} = V_{OUT(E)} \times 0.9$	200	-	-	mA	
Load Regulation	$V_{OUT}$	$V_{IN}=19V$ $1mA \leq I_{OUT} \leq 100mA$	-	120	380	mV	
Dropout Voltage <sup>(*3)</sup>	$V_{dif1}$	$I_{OUT}=30mA$	-	80	150	mV	
	$V_{dif2}$	$I_{OUT}=100mA$	-	280	380		
Supply Current	$I_{SS}$	$V_{IN}=19V$	-	15	30	$\mu A$	
Line Regulation	$\frac{V_{OUT}}{V_{IN} \cdot V_{OUT}}$	$I_{OUT}=1mA$ $19V \leq V_{IN} \leq 20V$	-	0.01	0.20	%/V	
Input Voltage	$V_{IN}$		-	-	20	V	-
Output Voltage Temperature Characteristics	$\frac{V_{OUT}}{T_{opr} \cdot V_{OUT}}$	$I_{OUT}=30mA$ $-40 \leq T_{opr} \leq 85$	-	$\pm 100$	-	ppm/	
Short-circuit Current	$I_{short}$	$V_{IN}=20V$	-	40	-	mA	

\*1.  $V_{OUT(T)}$  = Specified output voltage.

\*2.  $V_{OUT(E)}$  = Effective output voltage (i.e. the output voltage when " $V_{OUT(T)}+1.0V$ " is provided at the  $V_{IN}$  pin while maintaining certain  $I_{OUT}$  value).

\*3.  $V_{dif} = \{V_{IN1}^{(*5)} - V_{OUT1}^{(*4)}\}$

\*4.  $V_{OUT1}$  = A voltage equal to 98% of the output voltage when " $V_{OUT(T)} + 1.0V$ " is input.

\*5.  $V_{IN1}$  = The input voltage when  $V_{OUT1}$  is output following a gradual decrease in the input voltage.

## TEST CIRCUITS

CIRCUIT

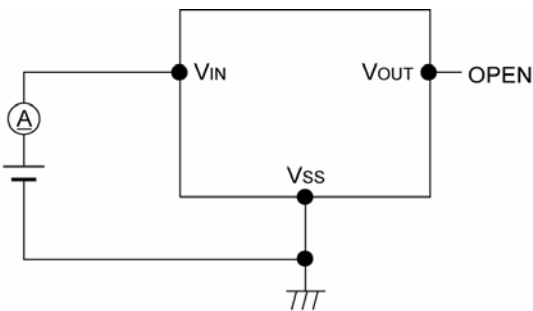

CIRCUIT

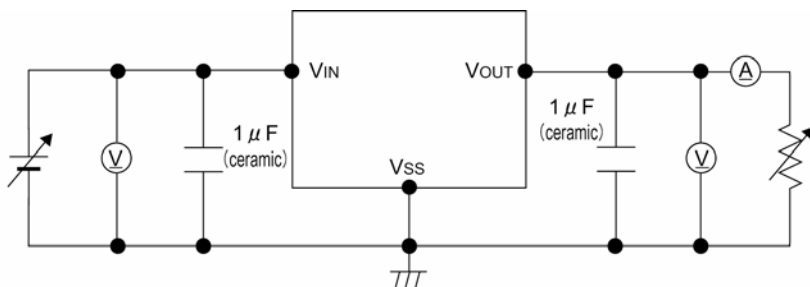

# TYPICAL PERFORMANCE CHARACTERISTICS

XC6202P182

(1) Output Voltage vs. Output Current

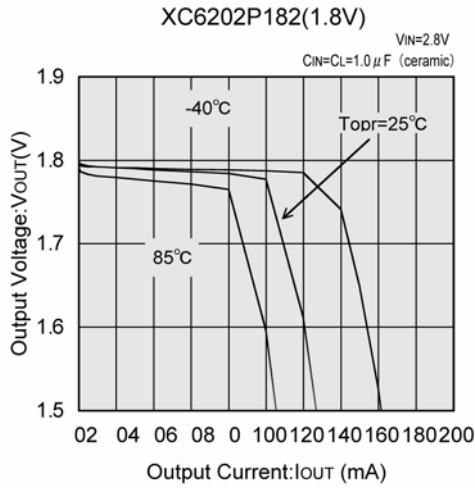

(2) Output Voltage vs. Input Voltage

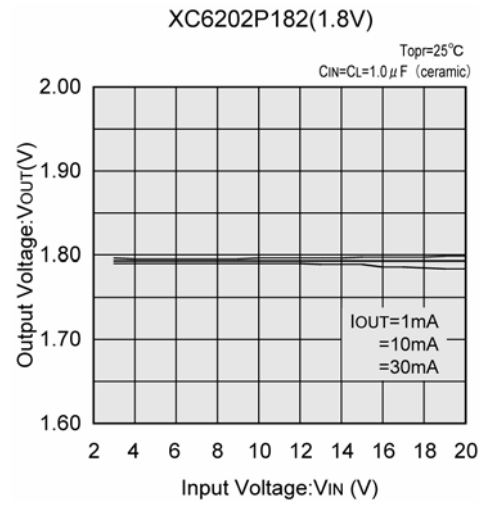
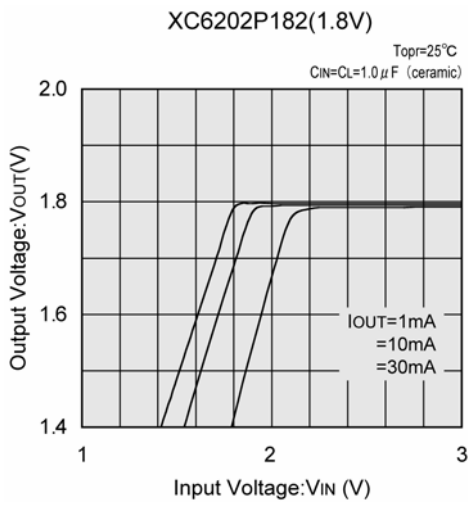

(3) Dropout Voltage vs. Output Current

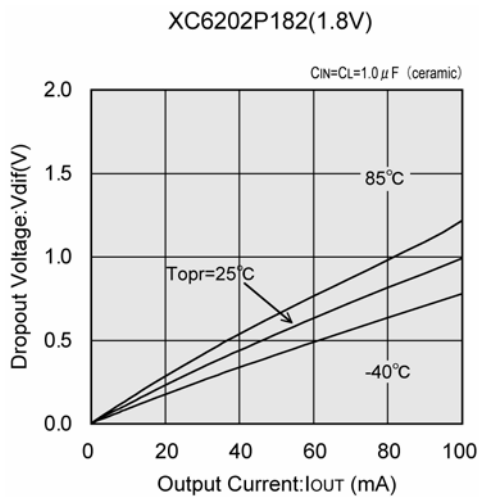

## TYPICAL PERFORMANCE CHARACTERISTICS (Continued)

XC6202P182 (Continued)

### (4) Supply Current vs. Input Voltage

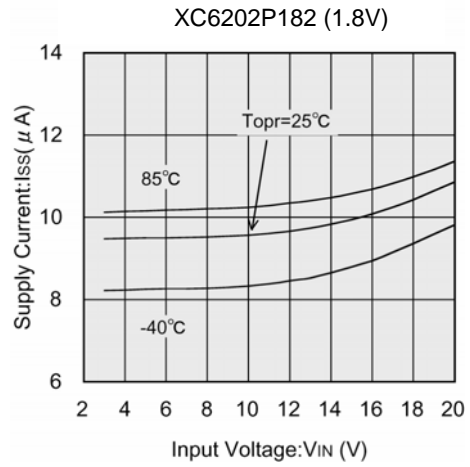
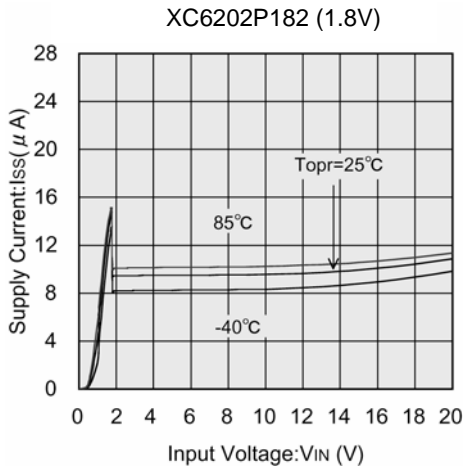

### (5) Output Voltage vs. Ambient Temperature

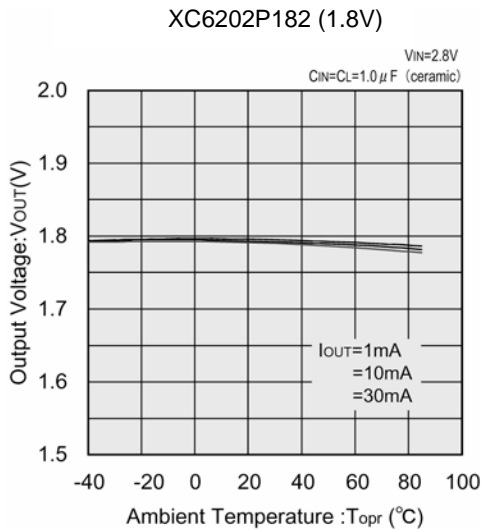

### (6) Supply Current vs. Ambient Temperature

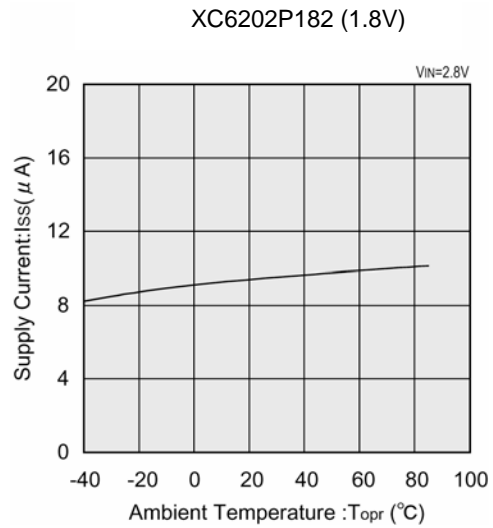

### (7) Current Limiter Circuit

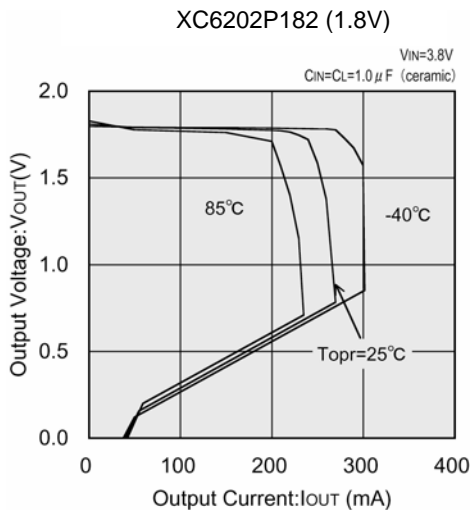



## TYPICAL PERFORMANCE CHARACTERISTICS (Continued)

XC6202P182 (Continued)

### (8) Input Transient Response 1

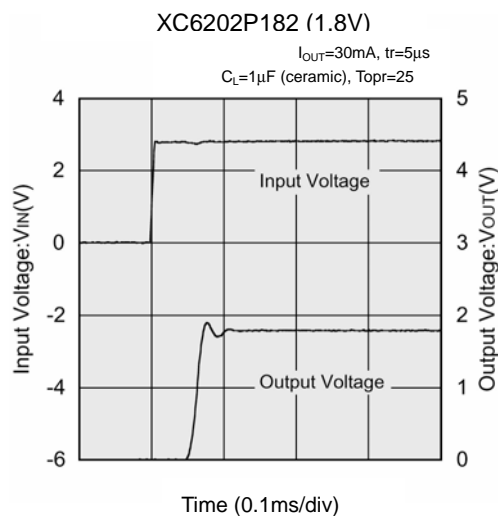
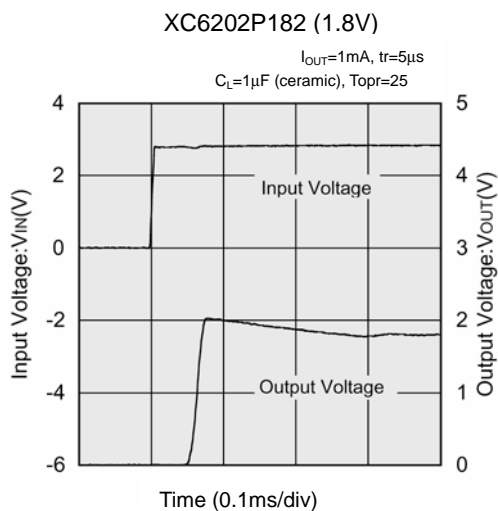

### (9) Input Transient Response 2

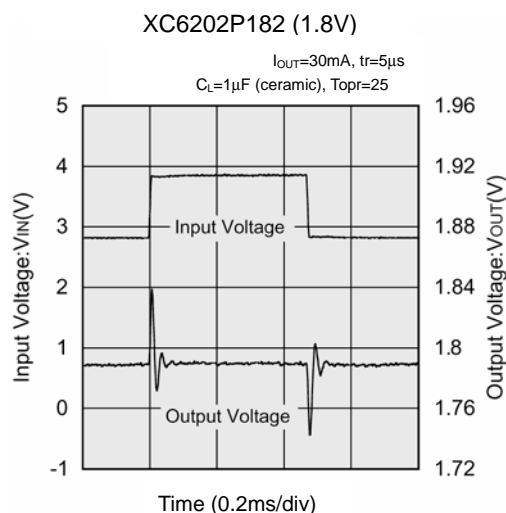
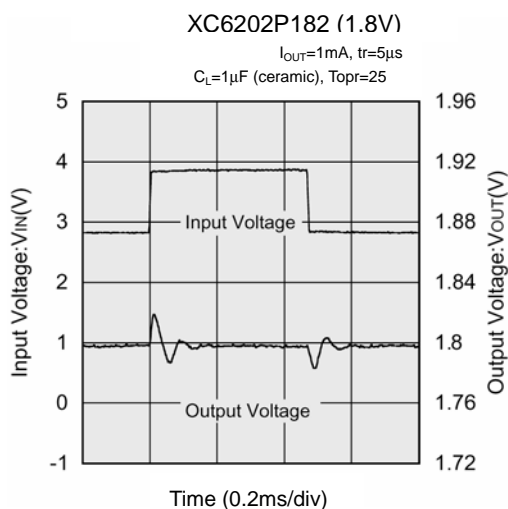

### (10) Load Transient Response

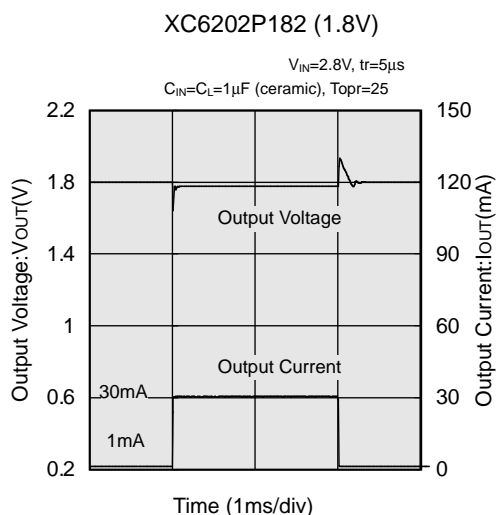

## TYPICAL PERFORMANCE CHARACTERISTICS (Continued)

XC6202P182 (Continued)

(11) Ripple Rejection Rate

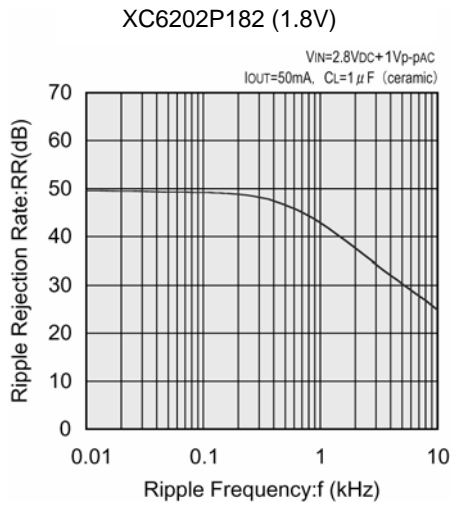
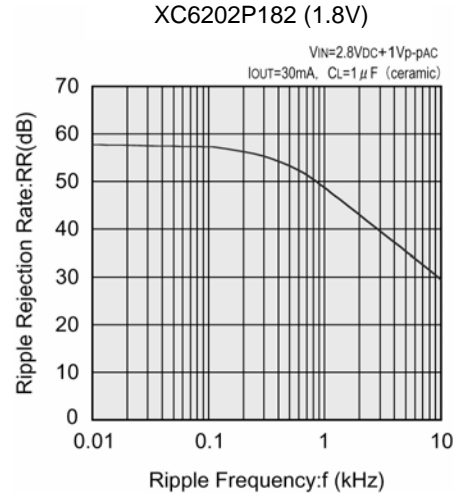
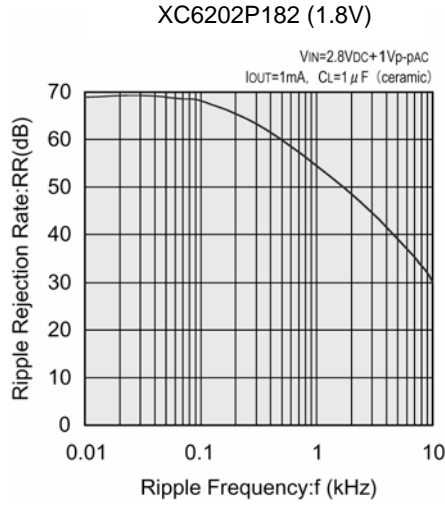

## TYPICAL PERFORMANCE CHARACTERISTICS (Continued)

XC6202P332

### (1) Output Voltage vs. Output Current

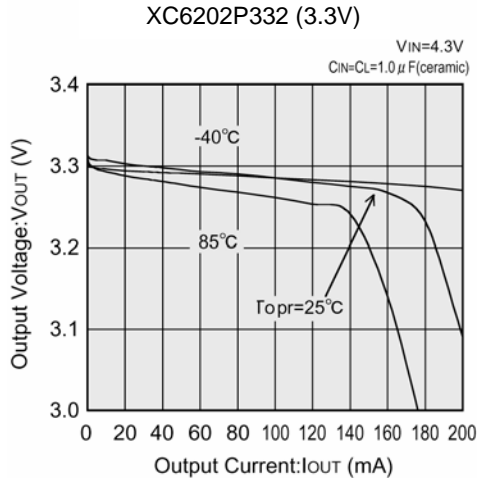

### (2) Output Voltage vs. Input Voltage

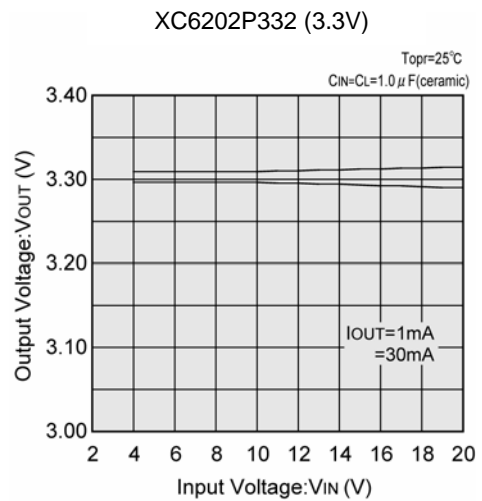
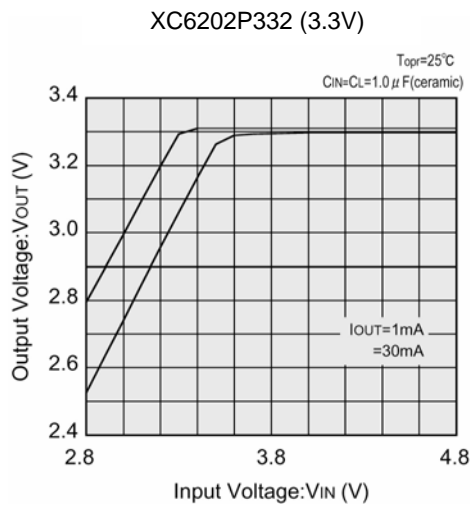

### (3) Dropout Voltage vs. Output Current

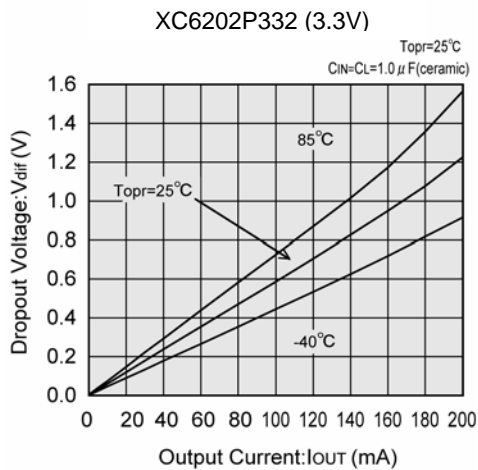

## TYPICAL PERFORMANCE CHARACTERISTICS (Continued)

XC6202P332 (Continued)

(4) Supply Current vs. Input Voltage

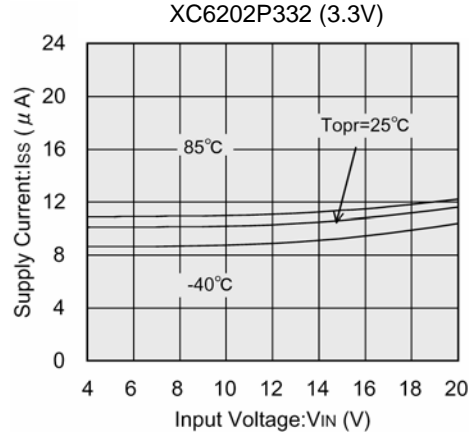
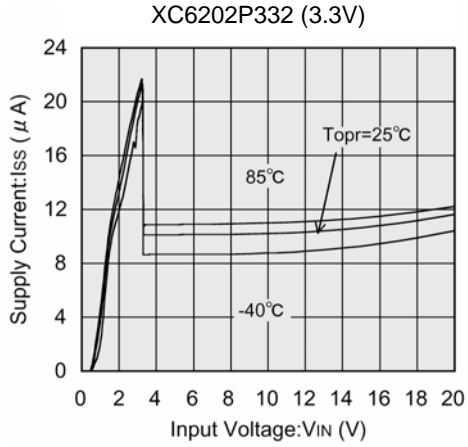

(5) Output Voltage vs. Ambient Temperature

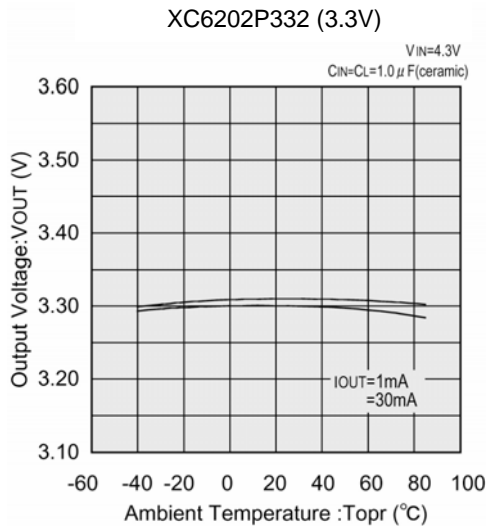

(6) Supply Current vs. Ambient Temperature

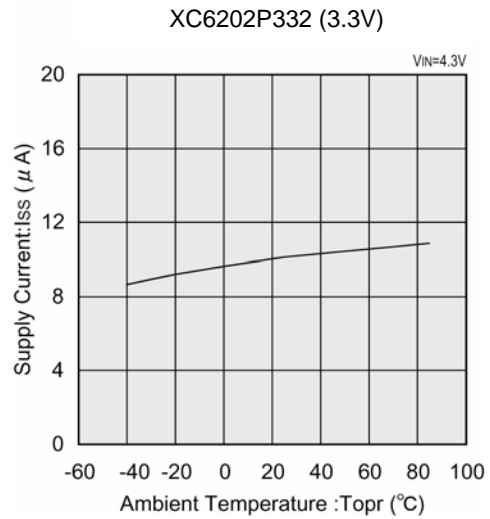

(7) Current Limiter Circuit

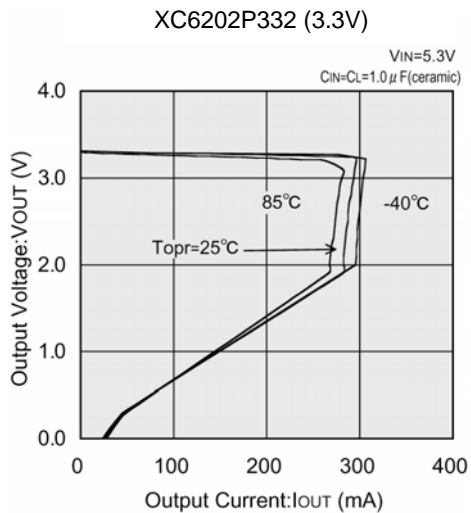

## TYPICAL PERFORMANCE CHARACTERISTICS (Continued)

XC6202P332 (Continued)

### (8) Input Transient Response 1

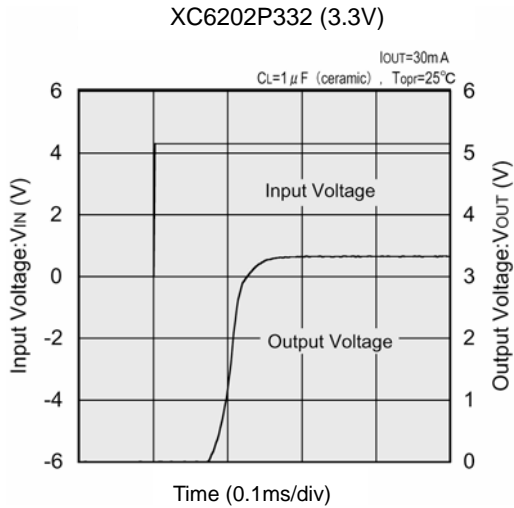

### (9) Input Transient Response 2

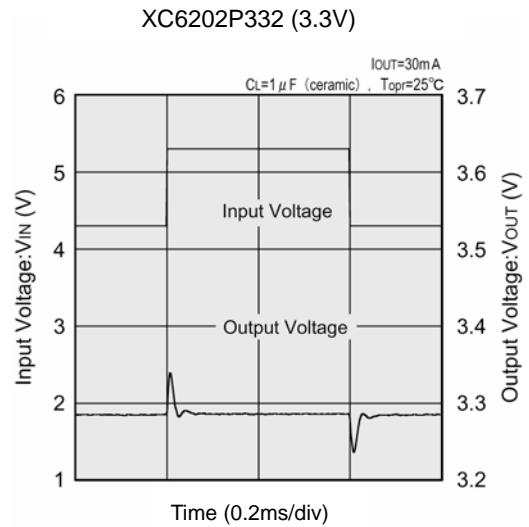
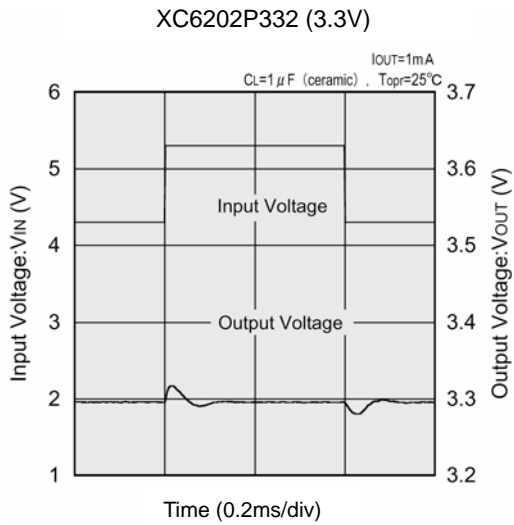

### (10) Load Transient Response

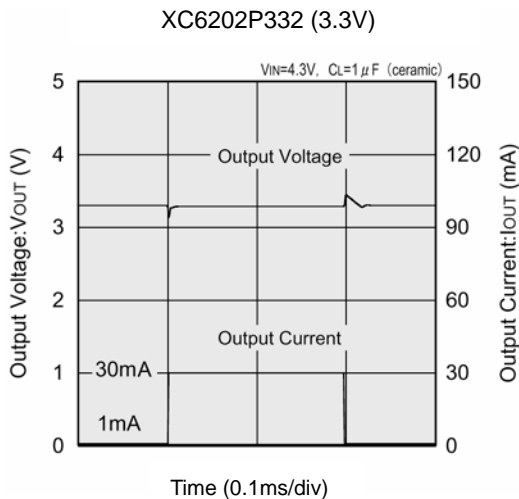

## TYPICAL PERFORMANCE CHARACTERISTICS (Continued)

XC6202P332 (Continued)

(11) Ripple Rejection Rate

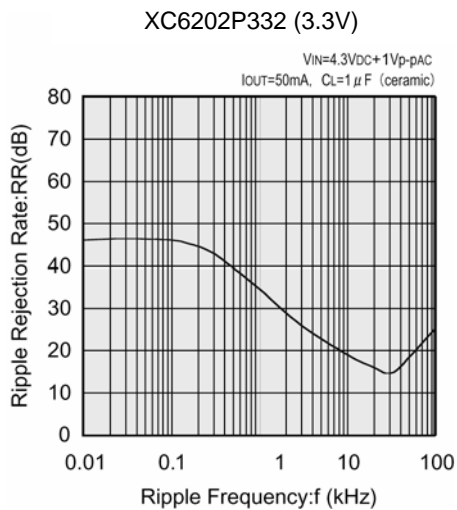
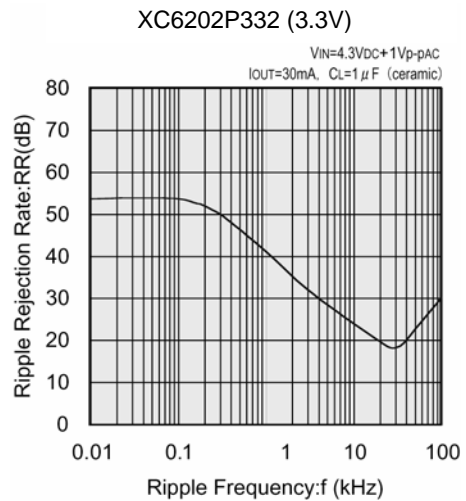
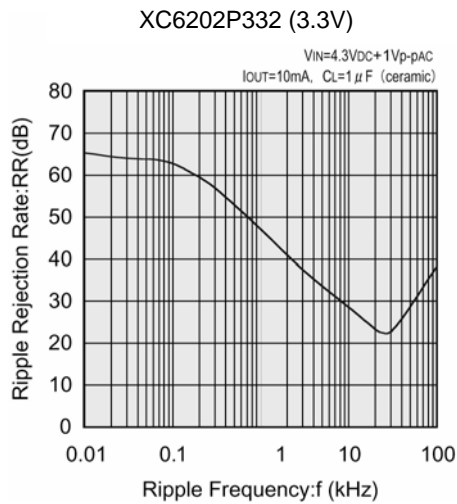
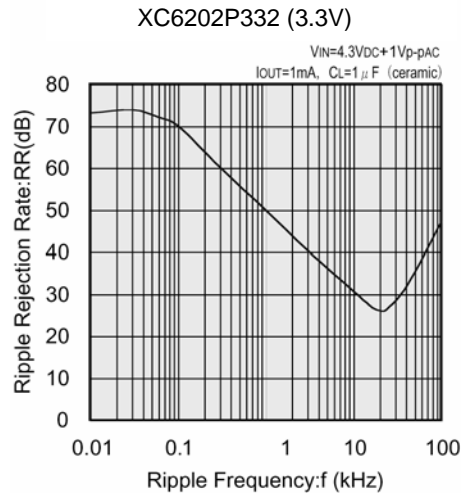
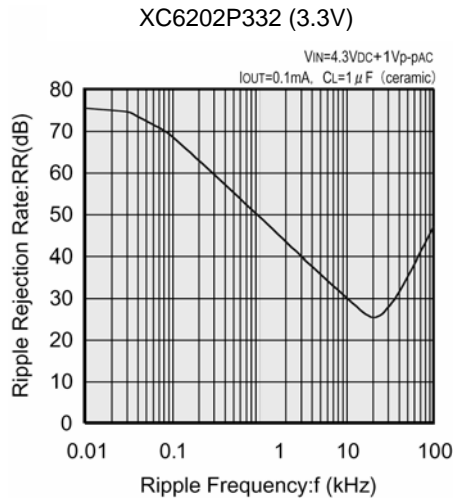

## TYPICAL PERFORMANCE CHARACTERISTICS (Continued)

XC6202P502

### (1) Output Voltage vs. Output Current

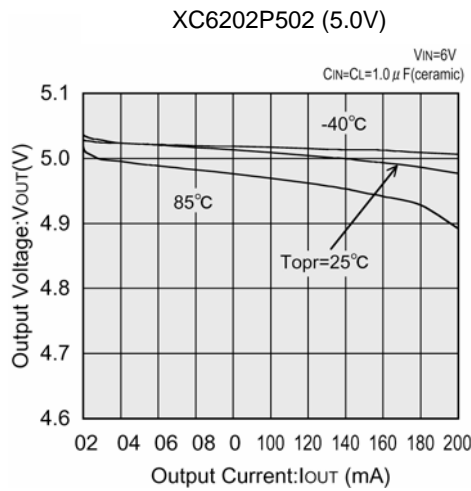

### (2) Output Voltage vs. Input Voltage

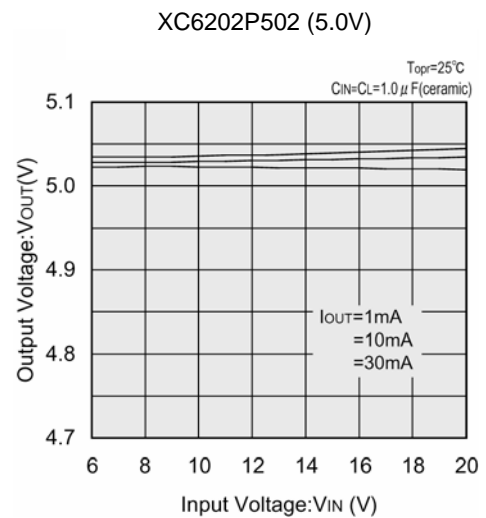
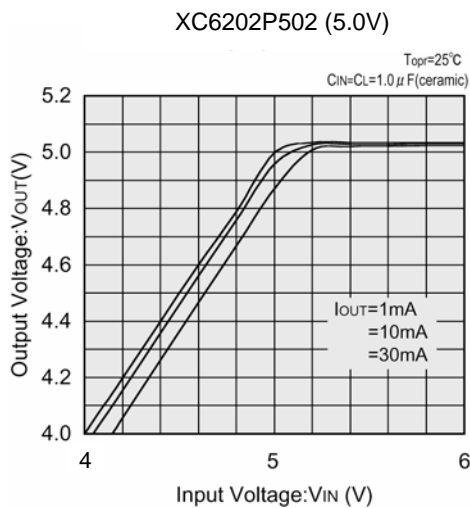

### (3) Dropout Voltage vs. Output Current

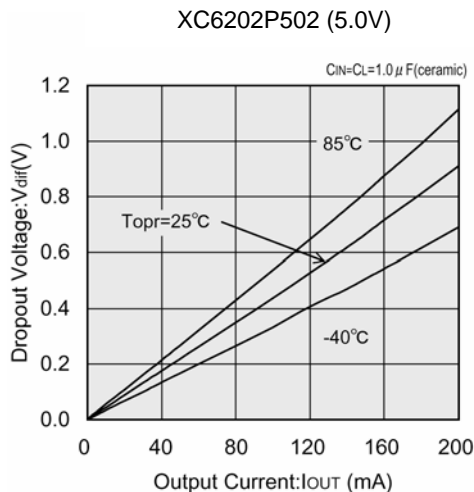

## TYPICAL PERFORMANCE CHARACTERISTICS (Continued)

XC6202P502 (Continued)

### (4) Supply Current vs. Input Voltage

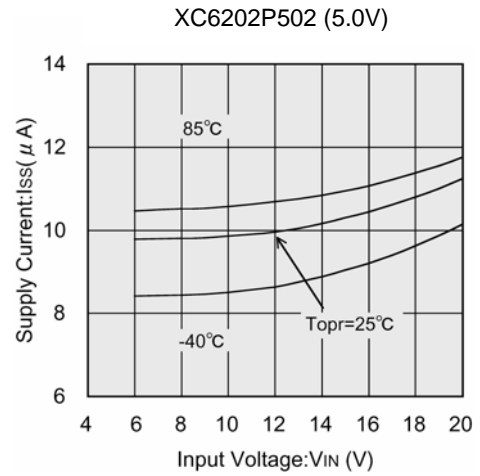
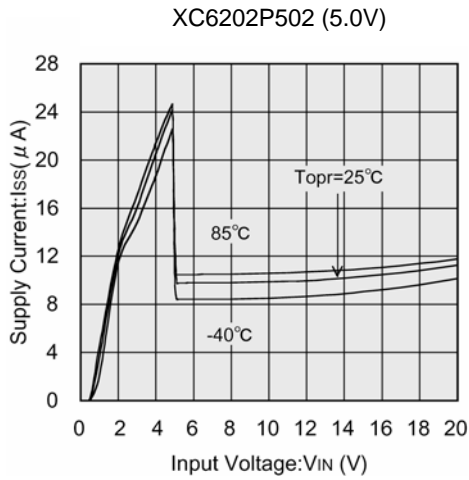

### (5) Output Voltage vs. Ambient Temperature

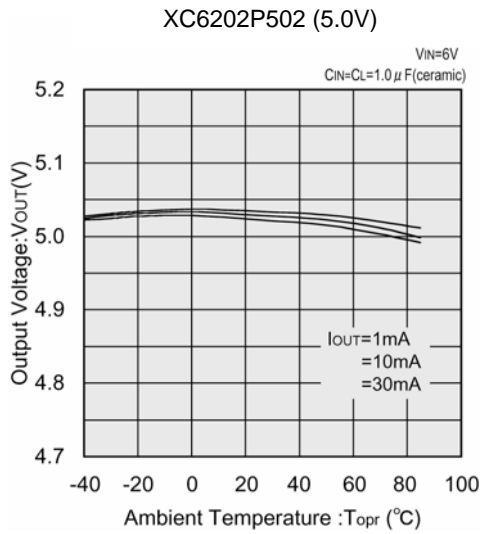

### (6) Supply Current vs. Ambient Temperature

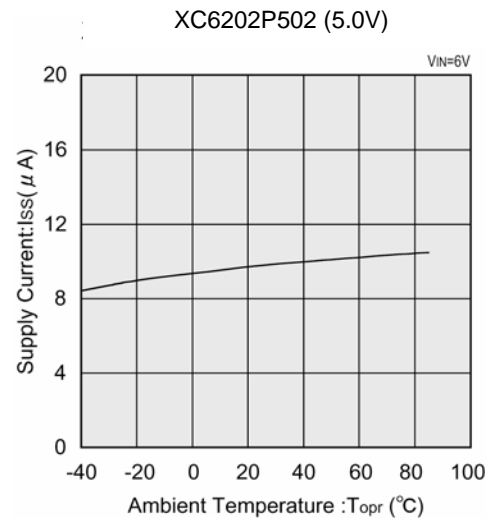

### (7) Current Limiter Circuit

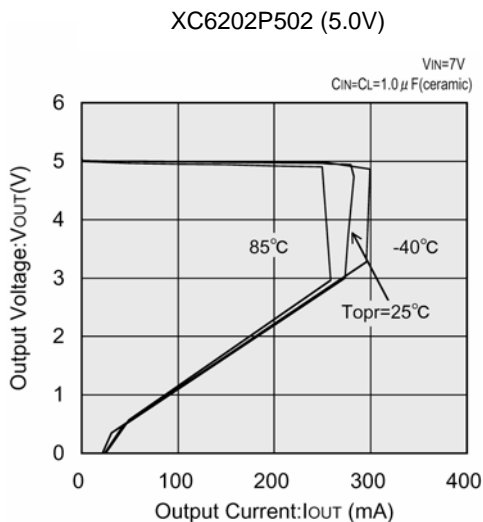



# TYPICAL PERFORMANCE CHARACTERISTICS (Continued)

XC6202P502 (Continued)

## (8) Input Transient Response 1

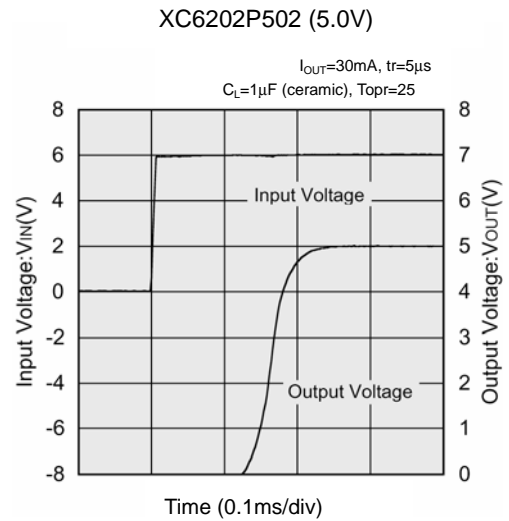
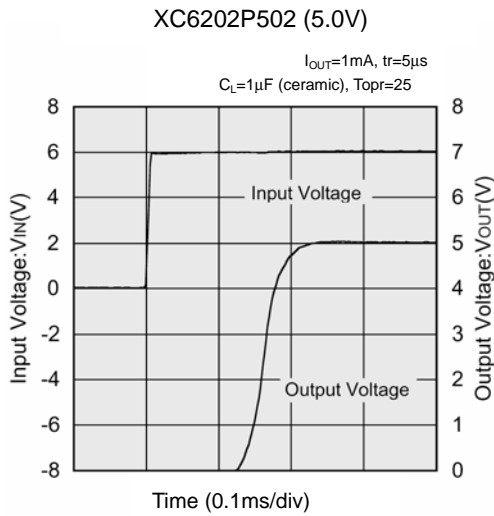

## (9) Input Transient Response 2

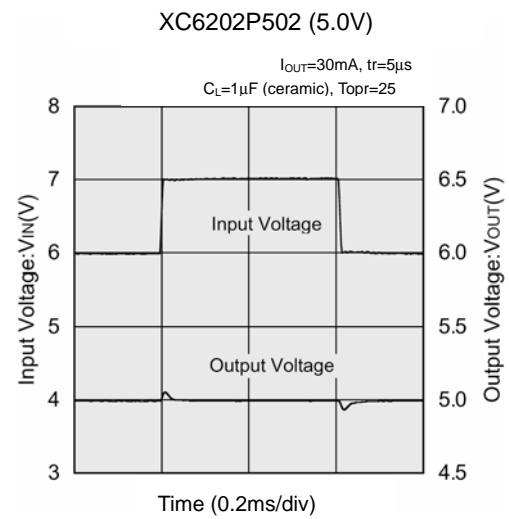
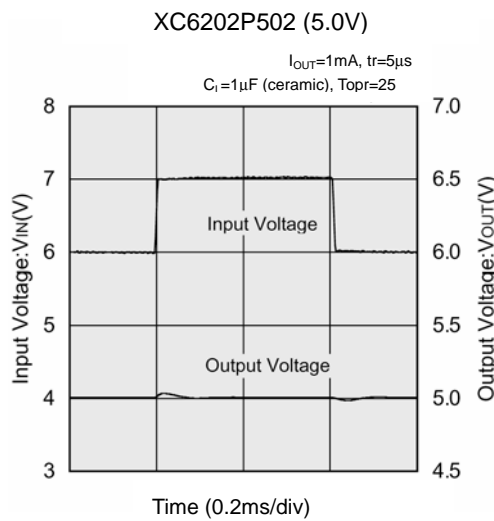

## (10) Load Transient Response

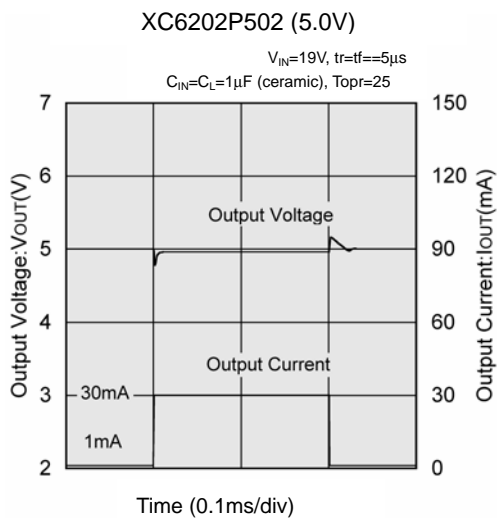

## TYPICAL PERFORMANCE CHARACTERISTICS (Continued)

XC6202P502 (Continued)

### (11) Ripple Rejection Rate

XC6202P502 (5.0V)

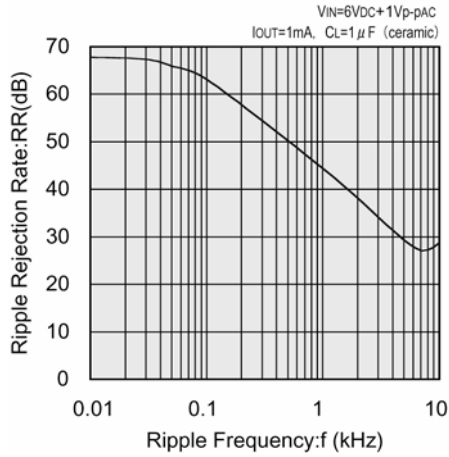

XC6202P502 (5.0V)

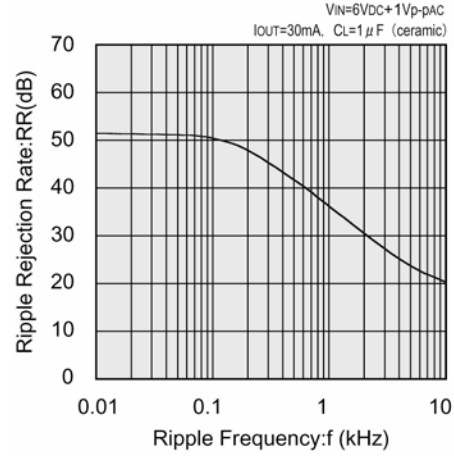

XC6202P502 (5.0V)

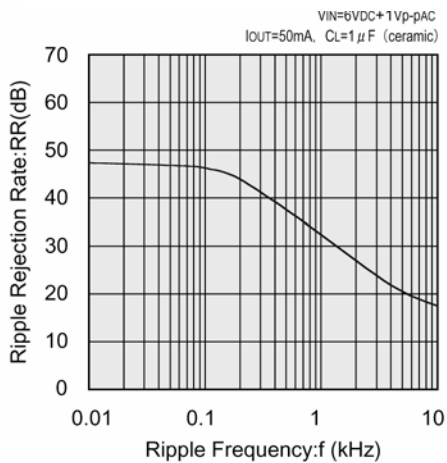

## TYPICAL PERFORMANCE CHARACTERISTICS (Continued)

XC6202PC02

### (1) Output Voltage vs. Output Current

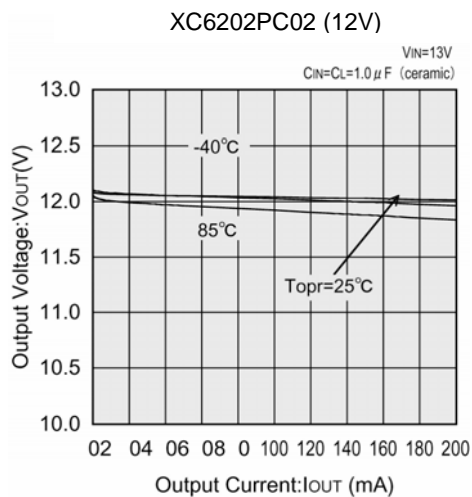

### (2) Output Voltage vs. Input Voltage

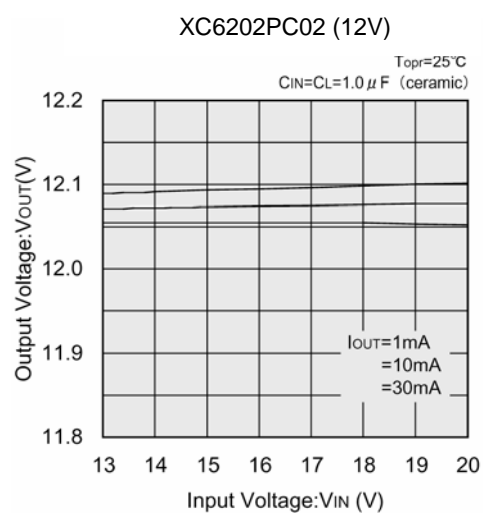
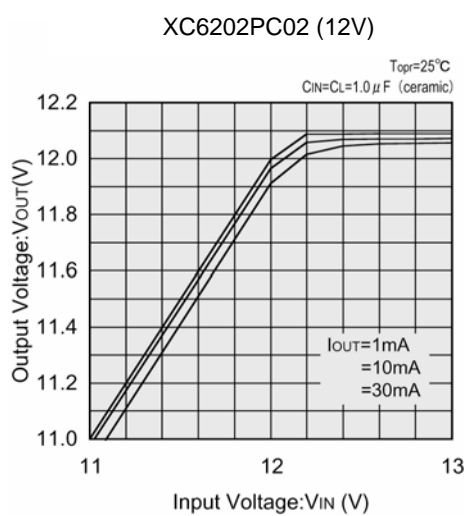

### (3) Dropout Voltage vs. Output Current

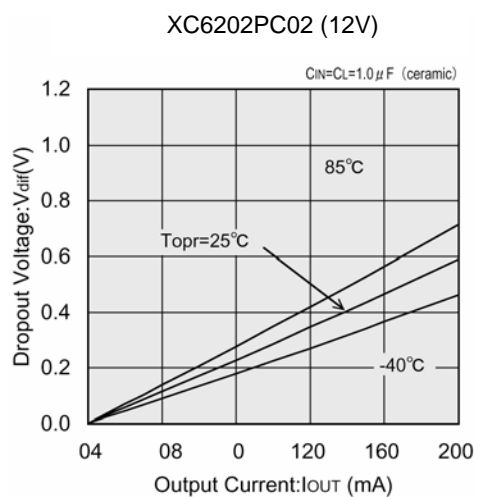

## TYPICAL PERFORMANCE CHARACTERISTICS (Continued)

XC6202PC02 (Continued)

(4) Supply Current vs. Input Voltage

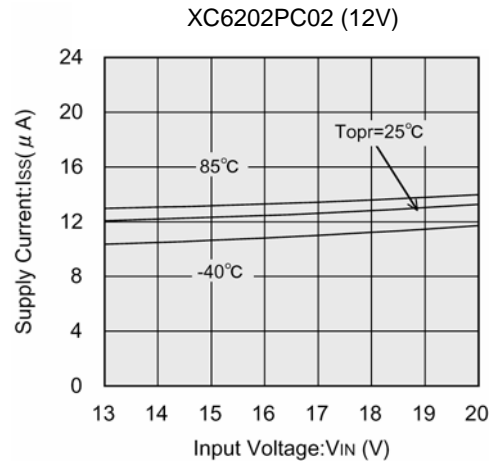
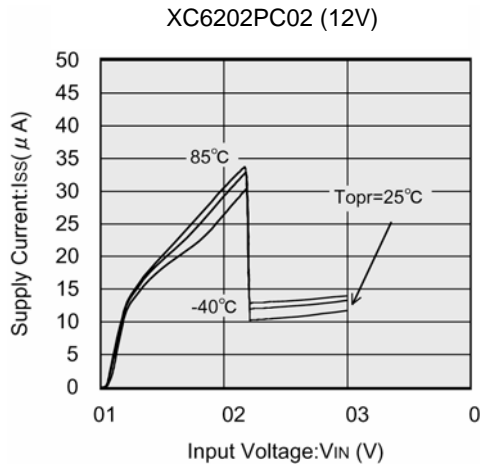

(5) Output Voltage vs. Ambient Temperature

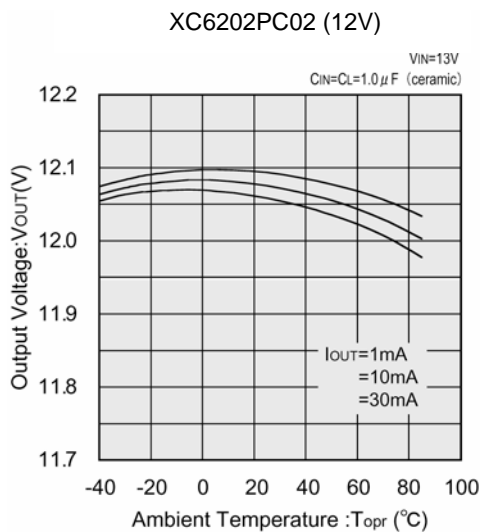

(6) Supply Current vs. Ambient Temperature

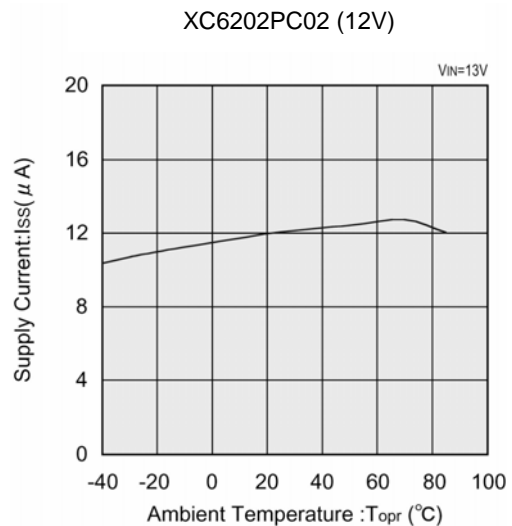

(7) Current Limiter Circuit

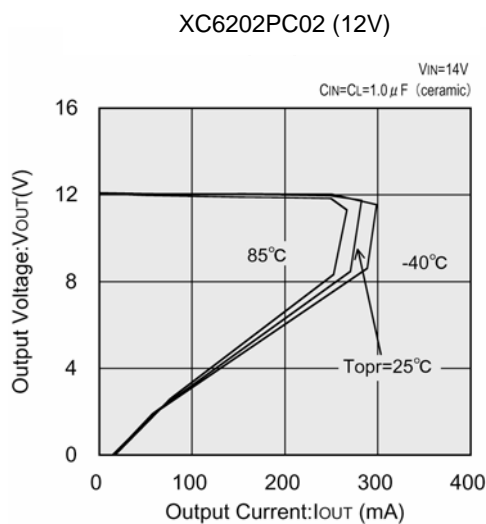

## TYPICAL PERFORMANCE CHARACTERISTICS (Continued)

XC6202PC02 (Continued)

### (8) Input Transient Response 1

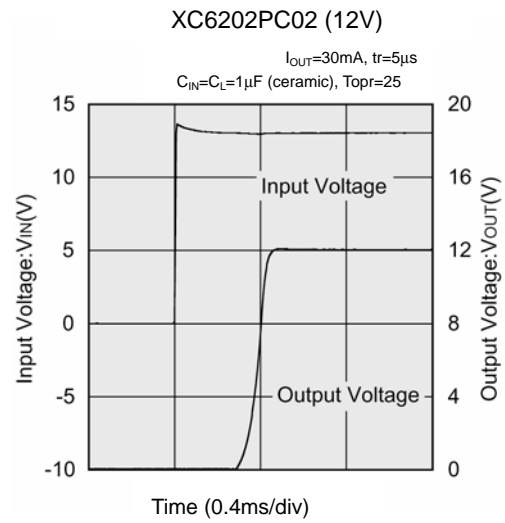
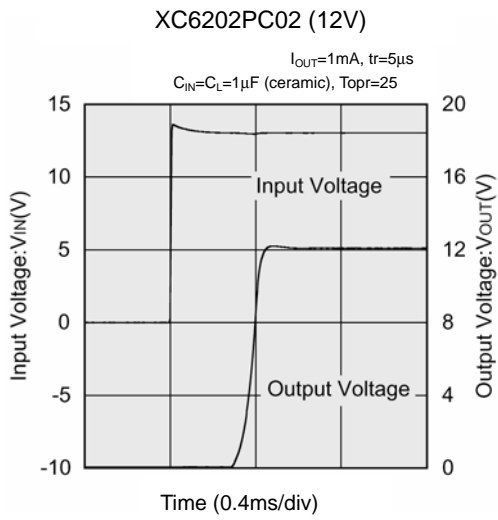

### (9) Input Transient Response 2

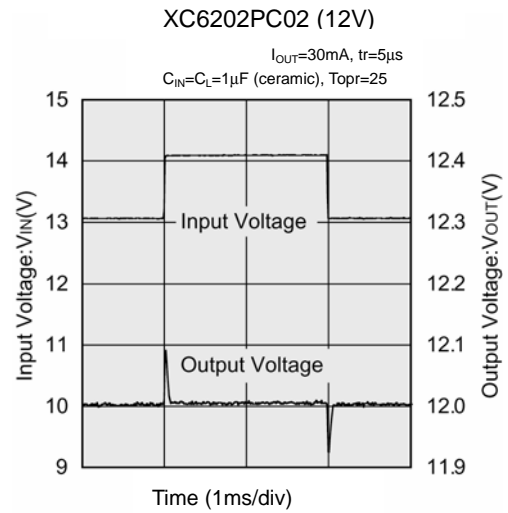
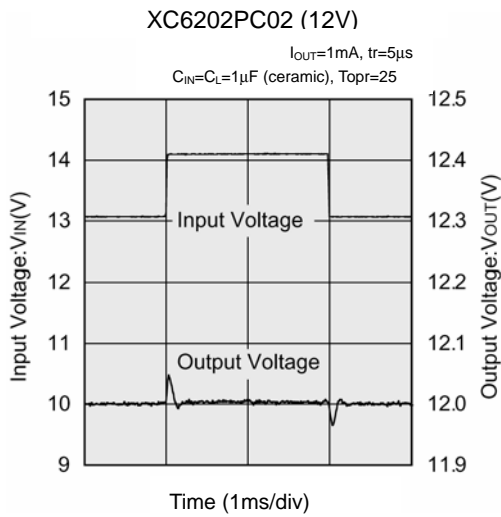

### (10) Load Transient Response

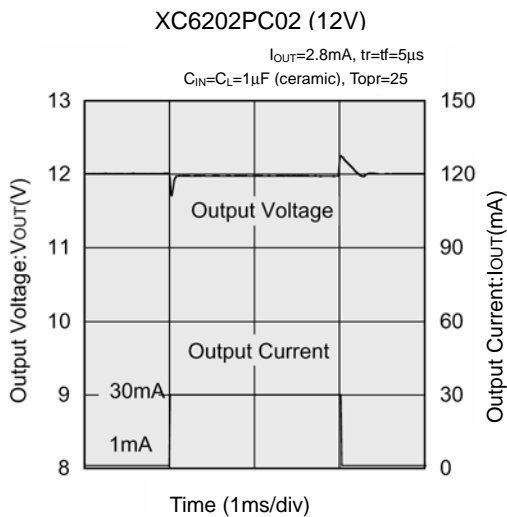

## TYPICAL PERFORMANCE CHARACTERISTICS (Continued)

XC6202PC02 (Continued)

### (11) Ripple Rejection Rate

XC6202PC02 (12V)

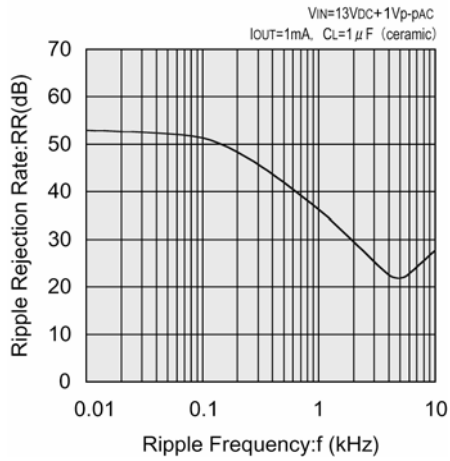

XC6202PC02 (12V)

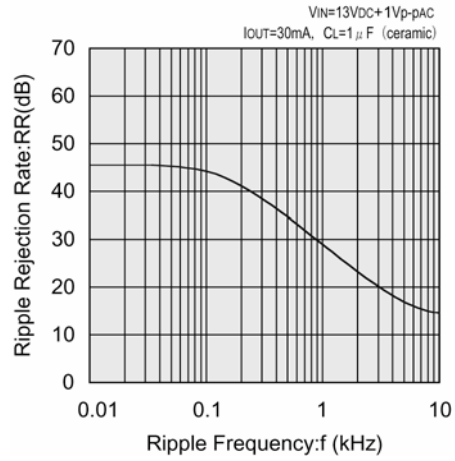

XC6202PC02 (12V)

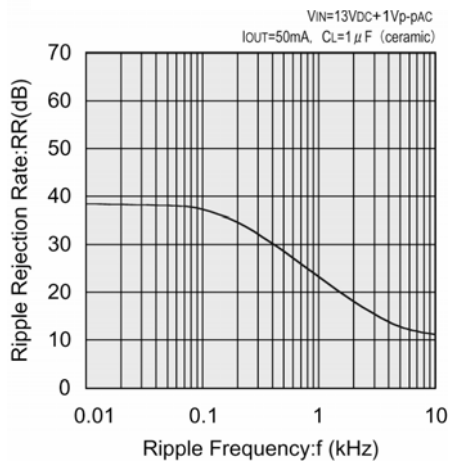

## TYPICAL PERFORMANCE CHARACTERISTICS (Continued)

XC6202PJ02

(1) Output Voltage vs. Output Current

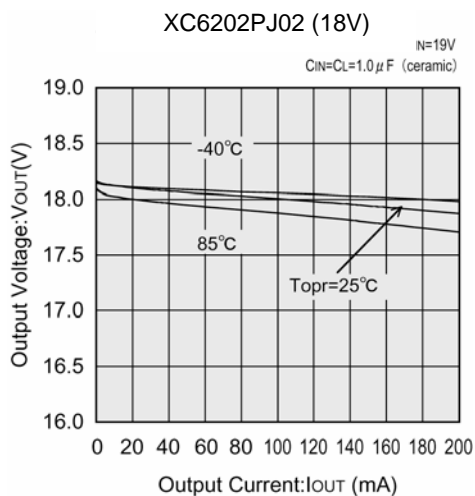

(2) Output Voltage vs. Input Voltage

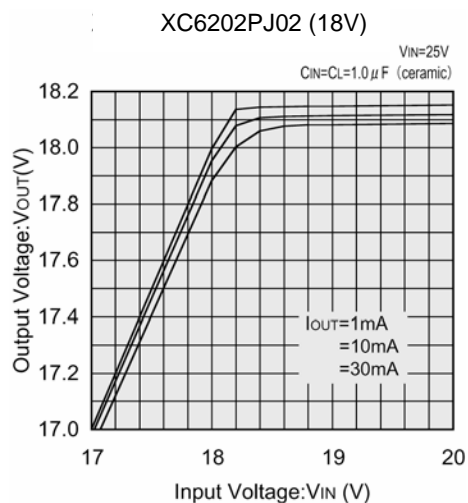

(3) Dropout Voltage vs. Output Current

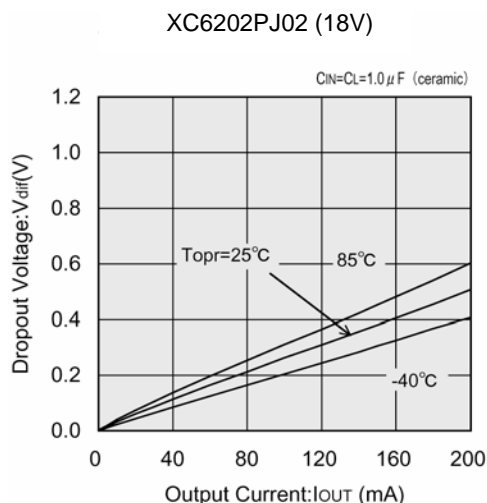

(4) Supply Current vs. Input Voltage

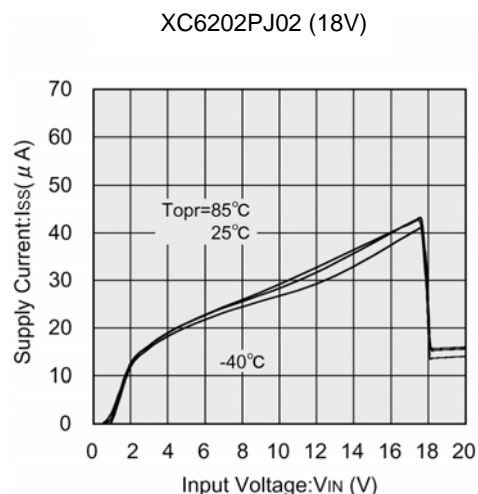

(5) Output Voltage vs. Ambient Temperature

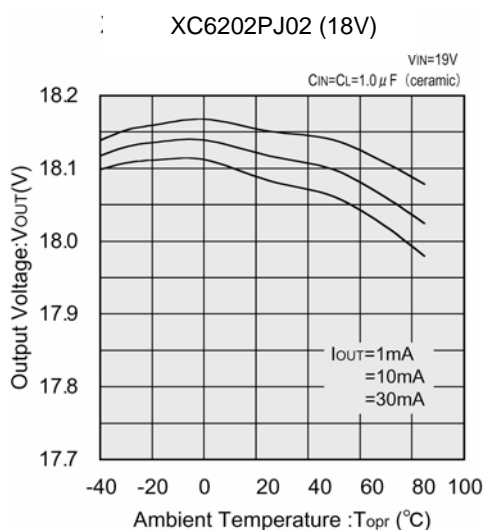

(6) Supply Current vs. Ambient Temperature

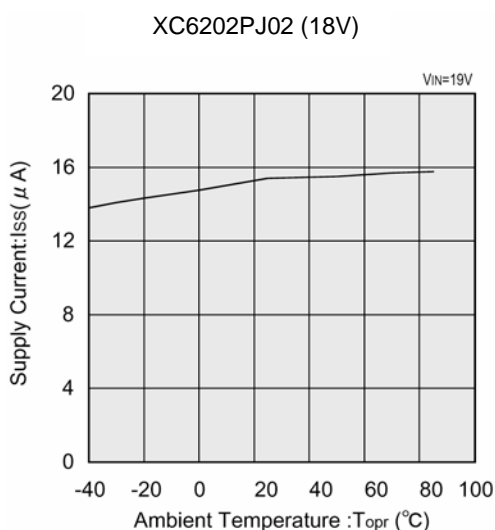

## TYPICAL PERFORMANCE CHARACTERISTICS (Continued)

XC6202PJ02 (Continued)

### (7) Current Limiter Circuit

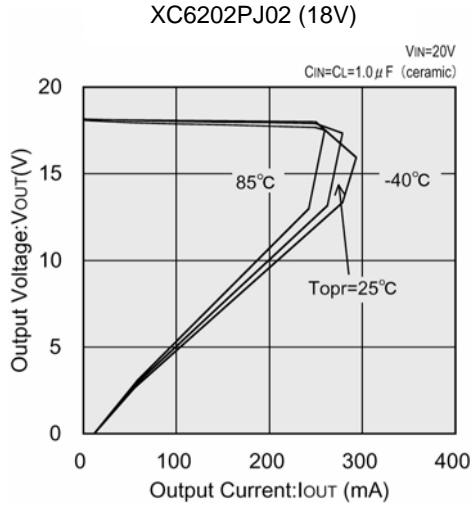

### (8) Input Transient Response 1

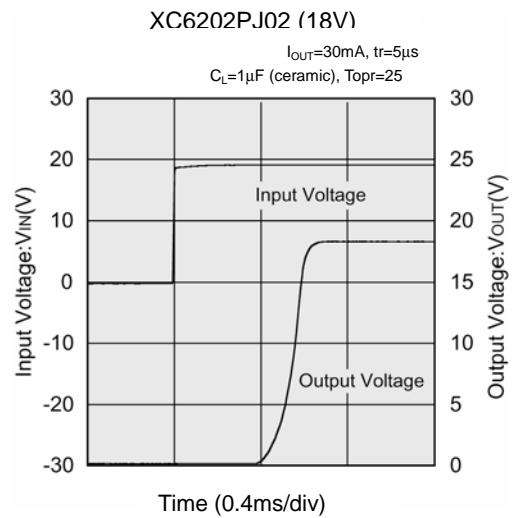
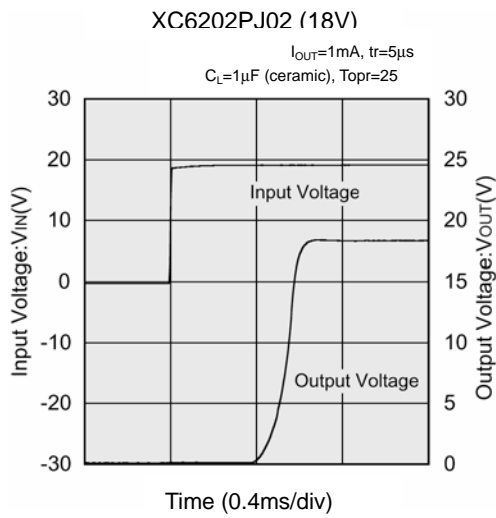

### (9) Input Transient Response 2

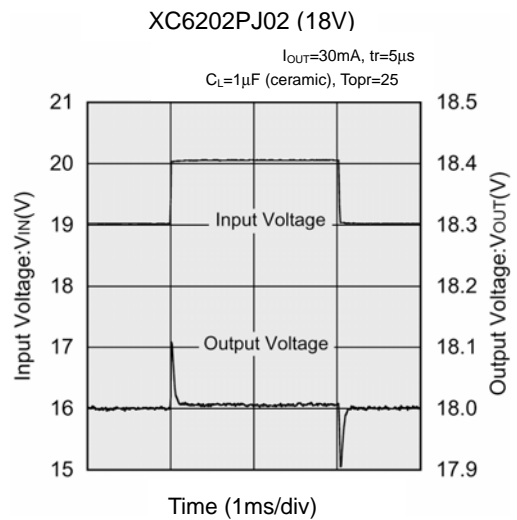
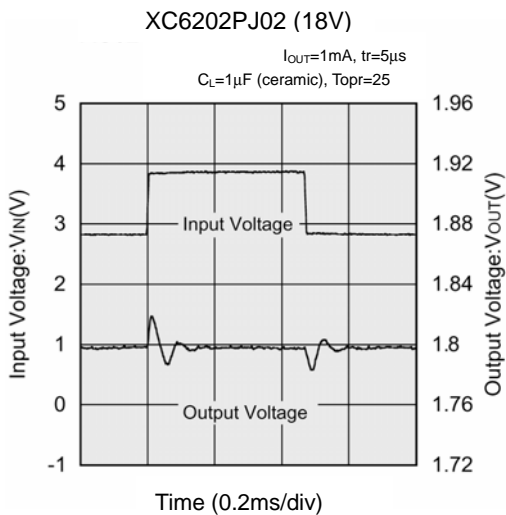



# TYPICAL PERFORMANCE CHARACTERISTICS (Continued)

XC6202PJ02 (Continued)

## (10) Load Transient Response

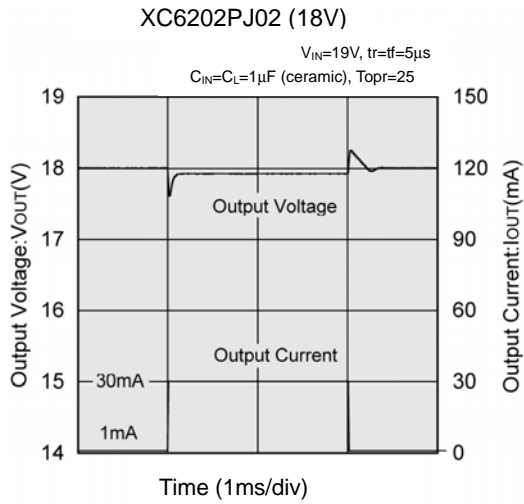

## (11) Ripple Rejection Rate

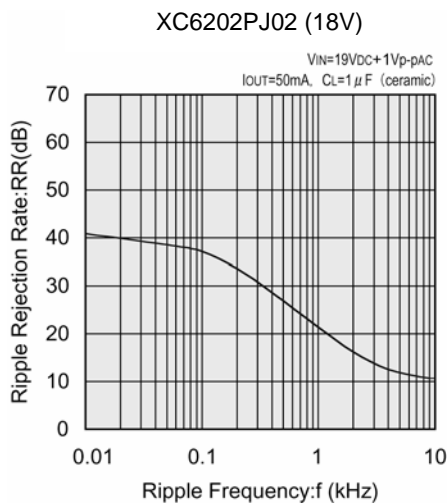
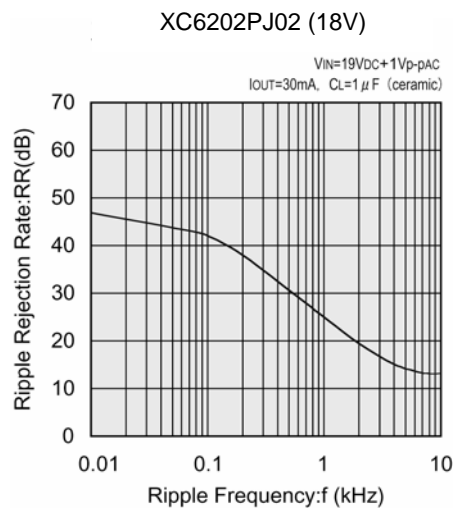
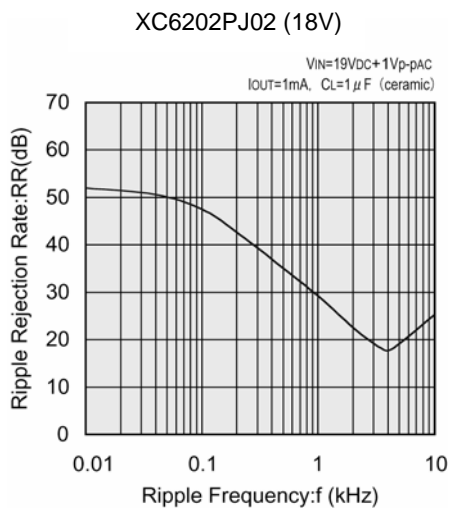

## PACKAGING INFORMATION

SOT-23

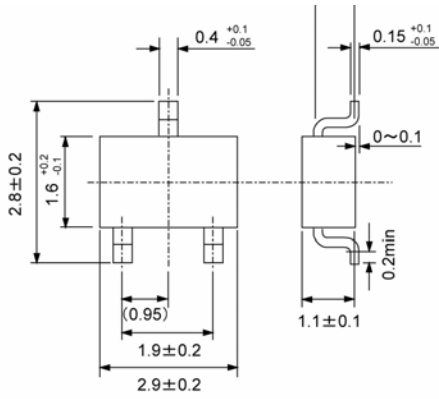

SOT-89

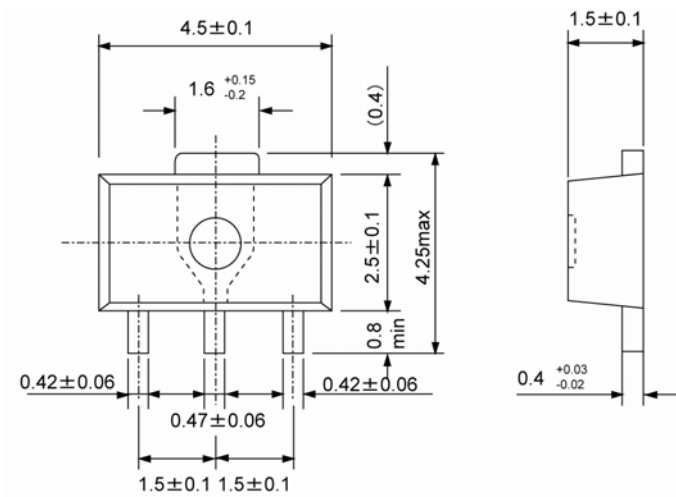

## PACKAGING INFORMATION (Continued)

### TO-92

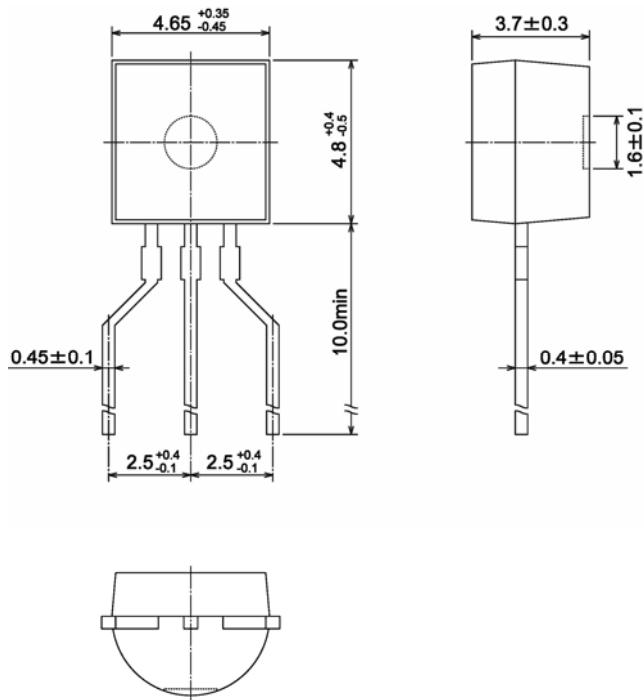

### SOT-223

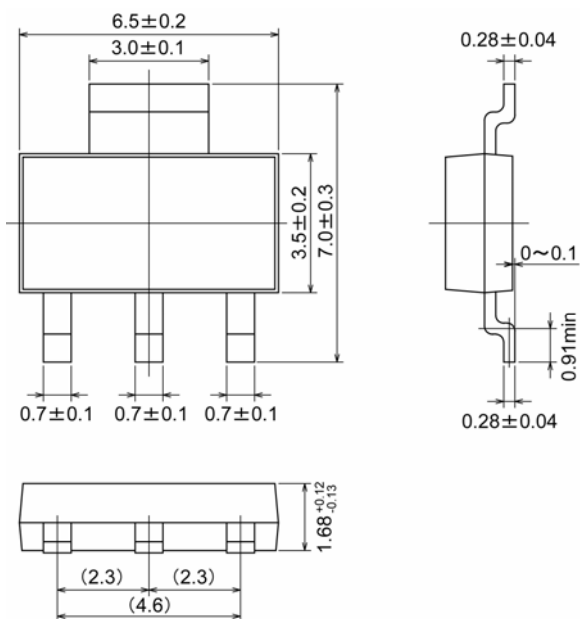

## PACKAGING INFORMATION (Continued)

USP-6B

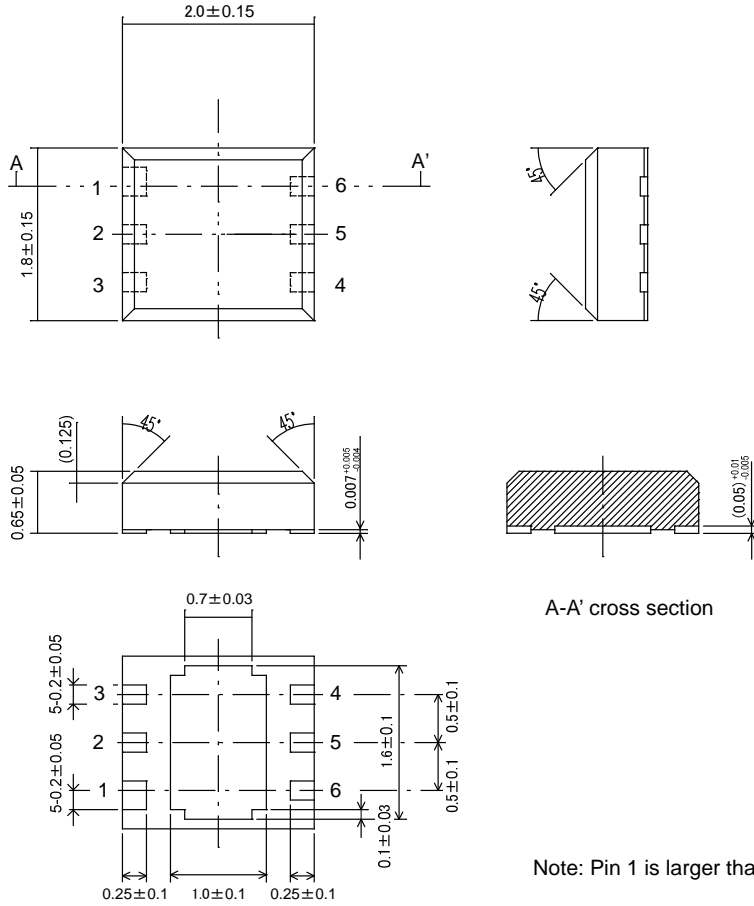

A-A' cross section

Note: Pin 1 is larger than the other pins

USP-6B Recommended Pattern Layout

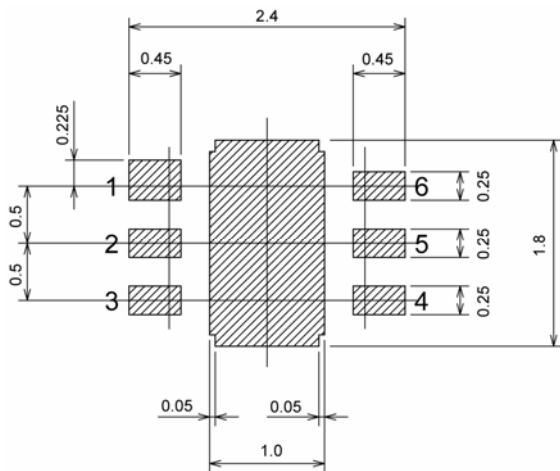

USP-6B Recommended Metal Mask Design

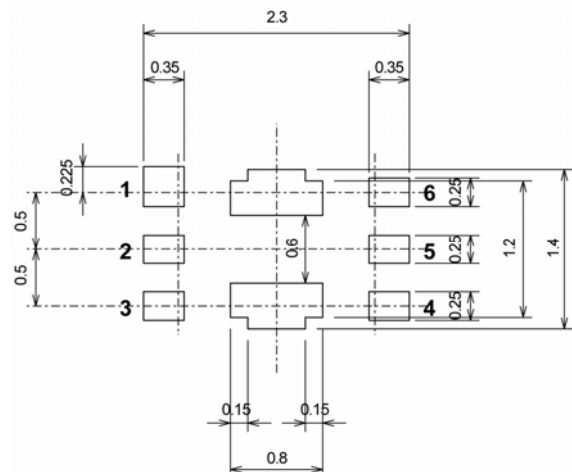

## MARKING RULE

SOT-23, SOT-89, SOT-223

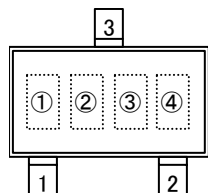

SOT-23  
(TOP VIEW)

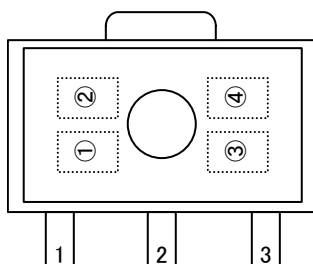

SOT-89  
(TOP VIEW)

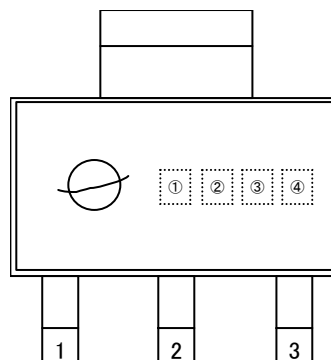

SOT-223  
(TOP VIEW)

Represents product series

MARK	PRODUCT SERIES
2	XC6202Pxxxxx

Represents output voltage range

MARK	VOLTAGE (V)	PRODUCT SERIES
4	0.1 ~ 3.0	XC6202Pxxxxx
5	3.1 ~ 6.0	
6	6.1 ~ 9.0	
7	9.1 ~ 12.0	
8	12.1 ~ 15.0	
9	15.1 ~ 18.0	

Represents output voltage

MARK	VOLTAGE (V)						MARK	VOLTAGE (V)					
0	-	3.1	6.1	9.1	12.1	15.1	F	-	4.6	7.6	10.6	13.6	16.6
1	-	3.2	6.2	9.2	12.2	15.2	H	-	4.7	7.7	10.7	13.7	16.7
2	-	3.3	6.3	9.3	12.3	15.3	K	1.8	4.8	7.8	10.8	13.8	16.8
3	-	3.4	6.4	9.4	12.4	15.4	L	1.9	4.9	7.9	10.9	13.9	16.9
4	-	3.5	6.5	9.5	12.5	15.5	M	2.0	5.0	8.0	11.0	14.0	17.0
5	-	3.6	6.6	9.6	12.6	15.6	N	2.1	5.1	8.1	11.1	14.1	17.1
6	-	3.7	6.7	9.7	12.7	15.7	P	2.2	5.2	8.2	11.2	14.2	17.2
7	-	3.8	6.8	9.8	12.8	15.8	R	2.3	5.3	8.3	11.3	14.3	17.3
8	-	3.9	6.9	9.9	12.9	15.9	S	2.4	5.4	8.4	11.4	14.4	17.4
9	-	4.0	7.0	10.0	13.0	16.0	T	2.5	5.5	8.5	11.5	14.5	17.5
A	-	4.1	7.1	10.1	13.1	16.1	U	2.6	5.6	8.6	11.6	14.6	17.6
B	-	4.2	7.2	10.2	13.2	16.2	V	2.7	5.7	8.7	11.7	14.7	17.7
C	-	4.3	7.3	10.3	13.3	16.3	X	2.8	5.8	8.8	11.8	14.8	17.8
D	-	4.4	7.4	10.4	13.4	16.4	Y	2.9	5.9	8.9	11.9	14.9	17.9
E	-	4.5	7.5	10.5	13.5	16.5	Z	3.0	6.0	9.0	12.0	15.0	18.0

Represents production lot number

0 to 9, A to Z reversed character 0 to 9, A to Z repeated. (G, I, J, O, Q, W excepted)

## MARKING RULE(Continued)

TO-92 (T TYPE)

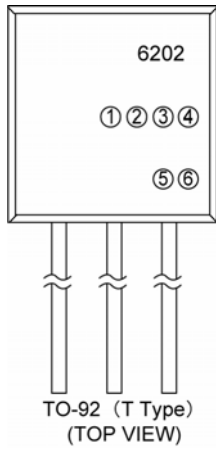

Represents type of regulator

MARK	PRODUCT SERIES
P	XC6202Pxxxx

Represents integer of the output voltage

MARK	VOLTAGE (V)	PRODUCT SERIES	MARK	VOLTAGE (V)	PRODUCT SERIES
1	1.x	XC6202P1xxxx	A	10.x	XC6202PAxxxx
2	2.x	XC6202P2xxxx	B	11.x	XC6202PBxxxx
3	3.x	XC6202P3xxxx	C	12.x	XC6202PCxxxx
4	4.x	XC6202P4xxxx	D	13.x	XC6202PDxxxx
5	5.x	XC6202P5xxxx	E	14.x	XC6202PExxxx
6	6.x	XC6202P6xxxx	F	15.x	XC6202PFxxxx
7	7.x	XC6202P7xxxx	G	16.x	XC6202PGxxxx
8	8.x	XC6202P8xxxx	H	17.x	XC6202PHxxxx
9	9.x	XC6202P9xxxx	J	18.x	XC6202PJxxxx

Represents decimal number of output voltage

MARK	VOLTAGE (V)	PRODUCT SERIES
3	x.3	XC6202Px3xxx
0	x.0	XC6202Px0xxx

Represents detect voltage accuracy

MARK	DETECT VOLTAGE ACCURACY	PRODUCT SERIES
2	Within $\pm 2\%$	XC6202Pxx2xx
1	Within $\pm 1\%$	XC6202Pxx1xx

Represents a least significant digit of production year

MARK	PRODUCTION YEAR
3	2003
4	2004

Represents production lot number

0 to 9, A to Z repeated (G, I, J, O, Q, W excepted)

Note: No character inversion used.

## MARKING RULE (Continued)

USP-6B

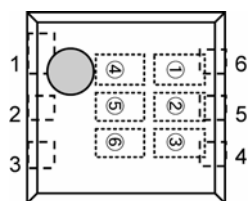

USP-6B  
(TOP VIEW)

Represents product series

MARK		PRODUCT SERIES
0	2	XC6202PxxxDx

Represents type of regulator

MARK	PRODUCT SERIES
P	XC6202Pxxxxx

Represents integer of the output voltage

MARK	VOLTAGE (V)	PRODUCT SERIES	MARK	VOLTAGE (V)	PRODUCT SERIES
1	1.x	XC6202P1xxDx	A	10.x	XC6202PAxxDx
2	2.x	XC6202P2xxDx	B	11.x	XC6202PBxxDx
3	3.x	XC6202P3xxDx	C	12.x	XC6202PCxxDx
4	4.x	XC6202P4xxDx	D	13.x	XC6202PDxxDx
5	5.x	XC6202P5xxDx	E	14.x	XC6202PExxDx
6	6.x	XC6202P6xxDx	F	15.x	XC6202PFxxDx
7	7.x	XC6202P7xxDx	G	16.x	XC6202PGxxDx
8	8.x	XC6202P8xxDx	H	17.x	XC6202PHxxDx
9	9.x	XC6202P9xxDx	J	18.x	XC6202PJxxDx

Represents decimal number of output voltage

MARK	VOLTAGE (V)	PRODUCT SERIES
3	X.3	XC6202Px3xDx
0	X.0	XC6202Px0xDx

Represents production lot number

0 to 9, A to Z repeated (G, I, J, O, Q, W excepted)

Note: No character inversion used.

1. The products and product specifications contained herein are subject to change without notice to improve performance characteristics. Consult us, or our representatives before use, to confirm that the information in this catalog is up to date.
2. We assume no responsibility for any infringement of patents, patent rights, or other rights arising from the use of any information and circuitry in this catalog.
3. Please ensure suitable shipping controls (including fail-safe designs and aging protection) are in force for equipment employing products listed in this catalog.
4. The products in this catalog are not developed, designed, or approved for use with such equipment whose failure of malfunction can be reasonably expected to directly endanger the life of, or cause significant injury to, the user.  
(e.g. Atomic energy; aerospace; transport; combustion and associated safety equipment thereof.)
5. Please use the products listed in this catalog within the specified ranges.  
Should you wish to use the products under conditions exceeding the specifications, please consult us or our representatives.
6. We assume no responsibility for damage or loss due to abnormal use.
7. All rights reserved. No part of this catalog may be copied or reproduced without the prior permission of Torex Semiconductor Ltd.

**TOREX SEMICONDUCTOR LTD.**