

# Silicon Double Balanced HMIC™ Mixer, 1700 - 2500 MHz

MA4EX240M-1225

## Features

- Low Cost Miniature Plastic Package
- 5.5 dB Typical Conversion Loss at 2100 MHz
- 6.7 dB Typical Conversion Loss at 2500 MHz
- +7 to +13 dBm LO Drive
- HMIC™ Patented Process
- Silicon Medium Barrier Schottky Diodes
- DC - 500 MHz IF Bandwidth

## Description

M/A-COM's MA4EX240M-1225 is a silicon monolithic 1700-2500 MHz double balanced mixer in a low cost miniature surface mount SOT-25 package. The die uses M/A-COM's unique HMIC™ silicon/glass process to achieve low loss passive elements while retaining the advantages of medium barrier silicon Schottky diodes.

## Applications

These mixers are well suited for high volume WLAN and cellular applications where small size and repeatability are required. Typical applications include frequency conversion, modulation, and demodulation for receivers and transmitters in both portable cellular and base station applications.

## Absolute Maximum Ratings<sup>1</sup>

Parameter	Maximum Ratings
Operating Temperature	-40 °C to +85 °C
Storage Temperature	-65 °C to +150 °C
Incident LO Power	+20 dBm
Incident RF Power	+20 dBm

1. Exceeding these limits may cause permanent damage.

## Package Outline

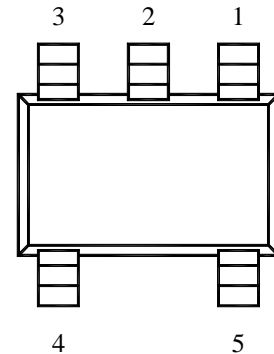

## PIN Configuration

PIN	Function	PIN	Function
1	GND	4	RF
2	GND	5	LO
3	IF		

## Functional Schematic

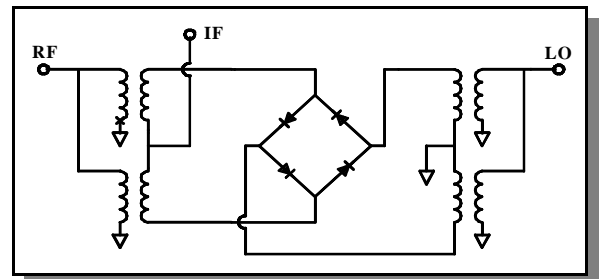

## Electrical Specifications: @ + 25 °C

Parameter	Frequency Range	Test Conditions	Units	Min.	Typ.	Max.
Conversion Loss	2100 MHz	LO Drive = +10 dBm	dB		5.5	6.0
	1700-2500 MHz	RF = -10 dBm, IF = 60 MHz	dB		6.2	7.5
L - R Isolation	2100 MHz	LO Drive = +10 dBm	dB		17.0	
	1700-2500 MHz	RF Level = -10 dBm	dB		16.0	
L - I Isolation	2100 MHz	LO Drive = +10 dBm	dB		22.0	
	1700-2500 MHz	RF Level = -10 dBm	dB		22.0	
R - I Isolation	2100 MHz	LO Drive = +10 dBm	dB		12.0	
	1700-2500 MHz	RF Level = -10 dBm	dB		13.0	
LO VSWR	2100 MHz	LO Drive = +10 dBm			2.3:1	
	1700-2500 MHz				2.5:1	
RF VSWR	2100 MHz	LO Drive = +10 dBm			1.2:1	
	1700-2500 MHz	RF Level = -10 dBm			1.7:1	
IF VSWR	DC - 400 MHz	LO Drive = +10 dBm RF Level = -10 dBm			1.6:1	
Input IP3	2100 MHz	LO Drive = +10 dBm	dBm	16.0	18.0	
	1700-2500 MHz	IF = 60 MHz	dBm	12.0	15.5	
Input 1 dB Compression	2100 MHz	LO Drive = +10 dBm	dBm		5.3	
	1700-2500 MHz	IF = 60 MHz	dBm		6.0	
IF 1 dB Bandwidth			MHz	0		500.0

M/A-COM Inc. and its affiliates reserve the right to make changes to the product(s) or information contained herein without notice. MA-COM makes no warranty, representation or guarantee regarding the suitability of its products for any particular purpose, nor does M/A-COM assume any liability whatsoever arising out of the use or application of any product(s) or information.

Visit [www.macom.com](http://www.macom.com) for additional data sheets and product information.

- North America: Tel. (800) 366-2266 2
- Asia/Pacific: Tel.+81-44-844-8296, Fax +81-44-844-8298
- Europe: Tel. +44 (1344) 869 595, Fax+44 (1344) 300 020

**tyco** / Electronics

**M/A-COM**

Typical Performance Curves (LO Drive = +10 dBm, RF = -10 dBm, IF = 60 MHz)

Conversion Loss

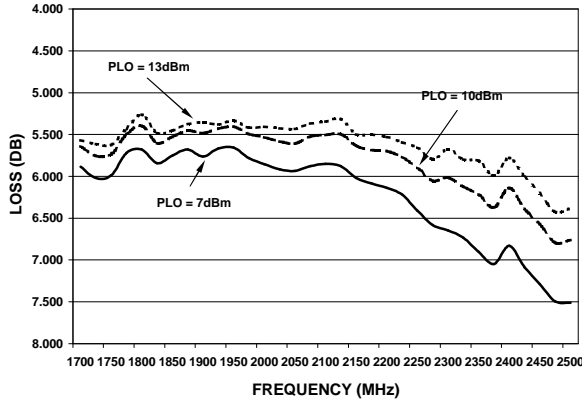

Isolation

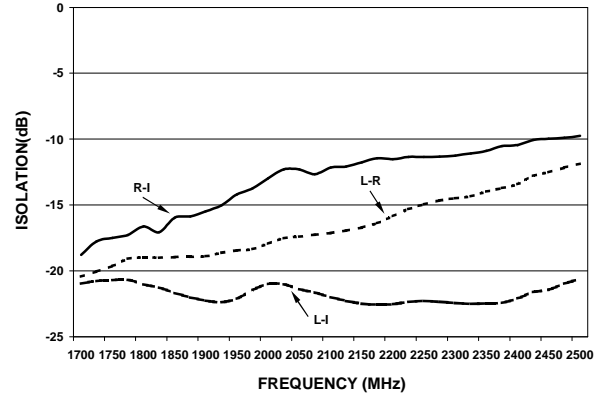

VSWR

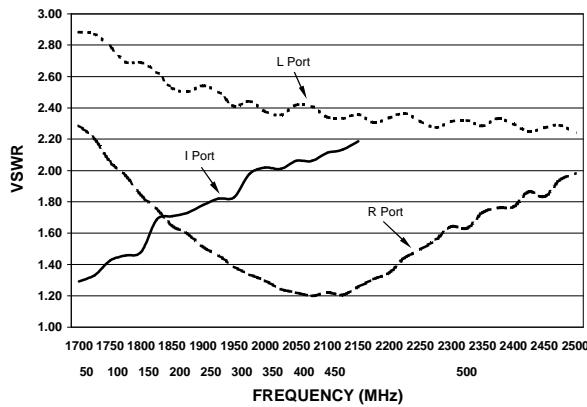

Input IP3 & 1 dB Compression Point

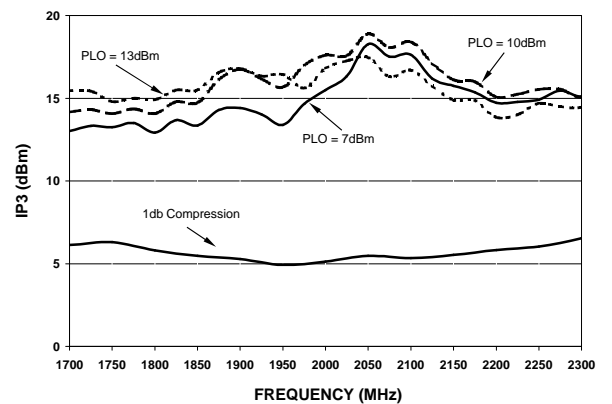

M/A-COM Inc. and its affiliates reserve the right to make changes to the product(s) or information contained herein without notice. MA-COM makes no warranty, representation or guarantee regarding the suitability of its products for any particular purpose, nor does M/A-COM assume any liability whatsoever arising out of the use or application of any product(s) or information.

Visit [www.macom.com](http://www.macom.com) for additional data sheets and product information.

- North America: Tel. (800) 366-2266
- Asia/Pacific: Tel.+81-44-844-8296, Fax +81-44-844-8298
- Europe: Tel. +44 (1344) 869 595, Fax+44 (1344) 300 020

Case Style - SOT-25

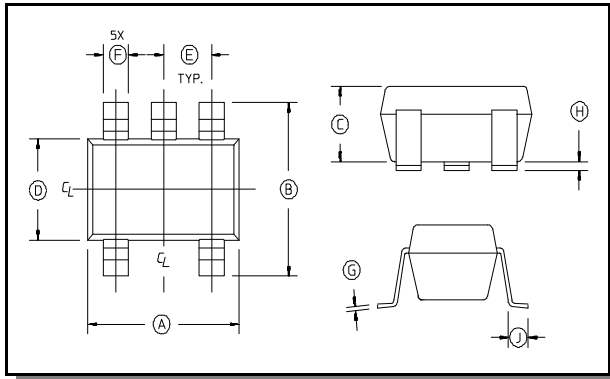

SOT-25 Dimensions

Dim	Inches		Millimeters	
	Min.	Max.	Min.	Max.
A	.106	.122	2.70	3.10
B	.100	.118	2.54	3.00
C	—	.051	—	1.30
D	.063 REF.		1.60 REF.	
E	.032	.043	.80	1.10
F	.014	.020	.35	.50
G	.003	—	.08	—
H	.000	.006	.00	.15
J	.018 REF.		.45 REF.	

Notes: 1. Leads Coplanarity should be 0.003 (0.08) max.

Ordering Information

Part Number	Package
MA4EX240M-1225	Tube
MA4EX240M-1225T	Tape and Reel

M/A-COM Inc. and its affiliates reserve the right to make changes to the product(s) or information contained herein without notice. MA-COM makes no warranty, representation or guarantee regarding the suitability of its products for any particular purpose, nor does M/A-COM assume any liability whatsoever arising out of the use or application of any product(s) or information.

Visit [www.macom.com](http://www.macom.com) for additional data sheets and product information.

- North America: Tel. (800) 366-2266 4
- Asia/Pacific: Tel.+81-44-844-8296, Fax +81-44-844-8298
- Europe: Tel. +44 (1344) 869 595, Fax+44 (1344) 300 020