

Surface Mount Plastic PIN Diodes

SMPP Series

Features

- Industry Standard Surface Mount Packages
- Low Capacitance Diodes
- Low Resistance Diodes
- Low Loss Switch Diodes
- High Isolation Switch Diodes
- Low Distortion Attenuator Diodes
- Fast Switching Diodes
- Single and Dual Diode Configurations
- Tape and Reel Packaging

Description

M/A-COM offers six unique PIN diodes in five industry standard, low cost, surface mount plastic packages. Within this series, the PIN diodes offered, feature a variety of low resistance, low capacitance and long minority carrier lifetime characteristics.

The MA4P275 has the lowest series resistance for Series Insertion Loss and Shunt Isolation switches. The MA4P789 has the lowest capacitance and offers the highest isolation in Series and Series-Shunt switches through 3 GHz. The MA4P277 and MA4P278 PIN diodes have longer intrinsic layers to produce better distortion performance in attenuators. The MA4P282 and MA4P274 are general-purpose PIN diodes useful in either switches or attenuators. These parts are available as single diodes, series pairs (ST), reverse series pairs (STR), common cathode pairs (CK), common anode pairs (CA), and unconnected pairs in the featured packages.

The SMPP series of PIN diodes is available in the SOT-23 (case style 287), the SOT-143 (case style 1068), the SOT-323 (case style 1146), the SOD-323 (case style 1141), and the SC-79 (case style 1279) packages. These packages are supplied on tape and reel for automatic pick and place assembly on surface mount circuit boards. The tape and reel suffix designation is a "T" at the end of the part number.

Absolute Maximum Ratings @ 25°C

| Parameter | Absolute Maximum |
|---|-------------------|
| Operating Temperature | -65 °C to +150 °C |
| Storage Temperature | -65 °C to +150 °C |
| Total (RF + DC) Power Dissipation @+25 °C Ambient | |
| SOT-23, SOT-143 | 250 mW |
| SOT-323, SOD-323, SC-79 | 150 mW |
| Reverse Voltage | Voltage Rating |
| Forward Current | 100 mA DC |

Package Outlines

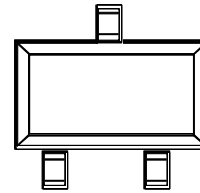
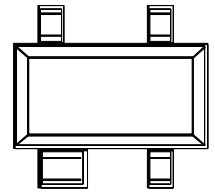
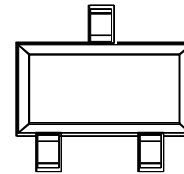
SOT-23

SOT-143

SOT-323

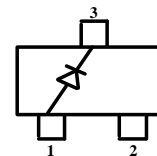
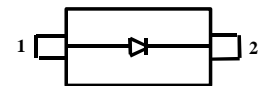
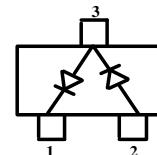
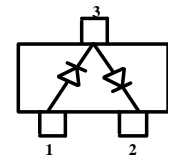
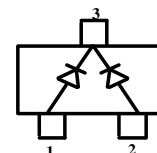
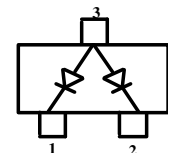
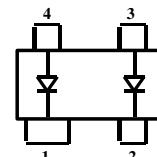
SOD-323

SC-79

Configurations (Top View)



Single

Single

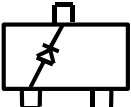
Series Pair

Series Pair Reverse

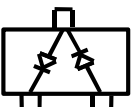
Common Cathode

Common Anode

Unconnected Pair

SOT-23

Electrical Specifications @ 25°C — SOT-23 Single Diode

| Model Number | Reverse Voltage V_R^1 (Volts) | Maximum Total Capacitance ² (pF) | Maximum R_S @ 10 mA ³ (Ohms) | Nominal Characteristics | | SOT-23 Ls = 1.4 nH Cpkg = 0.12 pF |
|--------------|---------------------------------|---|---|------------------------------------|---------------------------|---|
| | | | | Carrier Lifetime ⁴ (ms) | I-Region Thickness (mils) | |
| MA4P275-287T | 75 | 1.00 @ 20V | 0.5 | 0.2 | 0.4 |  |
| MA4P789-287T | 75 | 0.35 @ 20V | 1.5 | 0.2 | 0.4 | |
| MA4P282-287T | 100 | 1.20 @ 20V | 0.6 | 1.0 | 0.8 | |
| MA4P274-287T | 100 | 0.35 @ 50V | 3.0 | 1.0 | 2.0 | |
| MA4P277-287T | 200 | 0.35 @ 50V | 6.0 | 2.0 | 4.0 | |
| MA4P278-287T | 200 | 0.35 @ 50V | 10.0 | 3.0 | 7.0 | |

SOT-23 Series Pair⁵

| Model Number | Each Diode Reverse Voltage V_R^1 (Volts) | Each Diode Maximum Total Capacitance ² (pF) | Each Diode Maximum R_S @ 10 mA ³ (Ohms) | Nominal Characteristics | | SOT-23 Ls = 1.4 nH Cpkg = 0.12 pF |
|----------------|--|--|--|---|--------------------------------------|---|
| | | | | Each Diode Carrier Lifetime ⁴ (ms) | Each Diode I-Region Thickness (mils) | |
| MA4P275ST-287T | 75 | 1.00 @ 20V | 0.5 | 0.2 | 0.4 |  |
| MA4P789ST-287T | 75 | 0.35 @ 20V | 1.5 | 0.2 | 0.4 | |
| MA4P274ST-287T | 100 | 0.35 @ 50V | 3.0 | 1.0 | 2.0 | |
| MA4P282ST-287T | 100 | 1.20 @ 20V | 0.6 | 1.0 | 0.8 | |

SOT-23 Common Cathode

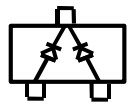
| Model Number | Each Diode Reverse Voltage V_R^1 (Volts) | Each Diode Maximum Total Capacitance ² (pF) | Each Diode Maximum R_S @ 10 mA ³ (Ohms) | Nominal Characteristics | | SOT-23 Ls = 1.4 nH Cpkg = 0.12 pF |
|----------------|--|--|--|---|--------------------------------------|---|
| | | | | Each Diode Carrier Lifetime ⁴ (ms) | Each Diode I-Region Thickness (mils) | |
| MA4P275CK-287T | 75 | 1.00 @ 20V | 0.5 | 0.2 | 0.4 |  |
| MA4P789CK-287T | 75 | 0.35 @ 20V | 1.5 | 0.2 | 0.4 | |
| MA4P282CK-287T | 100 | 1.20 @ 20V | 0.6 | 1.0 | 0.8 | |
| MA4P274CK-287T | 100 | 0.35 @ 50V | 3.0 | 1.0 | 2.0 | |

Specifications subject to change without notice.

- North America: Tel. (800) 366-2266
- Asia/Pacific: Tel. +81-44-844-8296, Fax +81-44-844-8298
- Europe: Tel. +44 (1344) 869 595, Fax +44 (1344) 300 020

Visit www.macom.com for additional data sheets and product information.

SOT-23 (Cont'd)

SOT-23 Common Anode

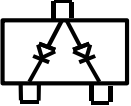
| Model Number | Each Diode Reverse Voltage V_R ¹ (Volts) | Each Diode Maximum Total Capacitance ² (pF) | Each Diode Maximum R_S @ 10 mA ³ (Ohms) | Nominal Characteristics | | SOT-23 Ls = 1.4 nH Cpkg = 0.12 pF |
|----------------|---|--|--|---|--------------------------------------|---|
| | | | | Each Diode Carrier Lifetime ⁴ (ms) | Each Diode I-Region Thickness (mils) | |
| MA4P275CA-287T | 75 | 1.00 @ 20V | 0.5 | 0.2 | 0.4 |  |
| MA4P789CA-287T | 75 | 0.35 @ 20V | 1.5 | 0.2 | 0.4 | |
| MA4P282CA-287T | 100 | 1.20 @ 20V | 0.6 | 1.0 | 0.8 | |
| MA4P274CA-287T | 100 | 0.35 @ 50V | 3.0 | 1.0 | 2.0 | |
| MA4P277CA-287T | 200 | 0.35 @ 50V | 6.0 | 2.0 | 4.0 | |
| MA4P278CA-287T | 200 | 0.35 @ 50V | 10.0 | 3.0 | 7.0 | |

1. The reverse current will not exceed 10 μ A at the Reverse Voltage rating.
2. Maximum total capacitance is measured at 1 MHz at the indicated voltage.
3. Maximum series resistance is measured at the specified current and a frequency of 100 MHz.
4. Nominal minority lifetime is measured at $I_F = 10$ mA, $I_R = 6$ mA, 90% recovery.
5. Also available as reverse polarity series pairs. Designated as "MA4P275STR-287", etc.

SOT-323

Electrical Specifications @ 25°C — SOT-323 Single Diode

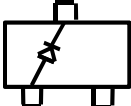
| Model Number | Reverse Voltage V_R ¹ (Volts) | Maximum Total Capacitance ² (pF) | Maximum R_S @ 10 mA ³ (Ohms) | Nominal Characteristics | | SOT-323 Ls = 1.3 nH Cpkg = 0.12 pF |
|---------------|--|---|---|------------------------------------|---------------------------|---|
| | | | | Carrier Lifetime ⁴ (ms) | I-Region Thickness (mils) | |
| MA4P275-1146T | 75 | 1.00 @ 20V | 0.5 | 0.2 | 0.4 |  |
| MA4P789-1146T | 75 | 0.35 @ 20V | 1.5 | 0.2 | 0.4 | |
| MA4P282-1146T | 100 | 1.20 @ 20V | 0.6 | 1.0 | 0.8 | |
| MA4P274-1146T | 100 | 0.35 @ 50V | 3.0 | 1.0 | 2.0 | |
| MA4P277-1146T | 200 | 0.35 @ 50V | 6.0 | 2.0 | 4.0 | |
| MA4P278-1146T | 200 | 0.35 @ 50V | 10.0 | 3.0 | 7.0 | |

Specifications subject to change without notice.

- North America: Tel. (800) 366-2266
- Asia/Pacific: Tel.+81-44-844-8296, Fax +81-44-844-8298
- Europe: Tel. +44 (1344) 869 595, Fax+44 (1344) 300 020

Visit www.macom.com for additional data sheets and product information.

SOT-323 (Cont'd)

SOT-323 Series Pair⁵

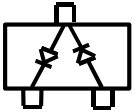
| Model Number | Each Diode Reverse Voltage V_R ¹ (Volts) | Each Diode Maximum Total Capacitance ² (pF) | Each Diode Maximum R_s @ 10 mA ³ (Ohms) | Nominal Characteristics | | SOT-323 Ls = 1.3 nH Cpkg = 0.12 pF |
|-----------------|---|--|--|---|--------------------------------------|---|
| | | | | Each Diode Carrier Lifetime ⁴ (ms) | Each Diode I-Region Thickness (mils) | |
| MA4P275ST-1146T | 75 | 1.00 @ 20V | 0.5 | 0.2 | 0.4 |  |
| MA4P789ST-1146T | 75 | 0.35 @ 20V | 1.5 | 0.2 | 0.4 | |
| MA4P274ST-1146T | 100 | 0.35 @ 50V | 3.0 | 1.0 | 2.0 | |

SOT-323 Common Cathode

| Model Number | Each Diode Reverse Voltage V_R ¹ (Volts) | Each Diode Maximum Total Capacitance ² (pF) | Each Diode Maximum R_s @ 10 mA ³ (Ohms) | Nominal Characteristics | | SOT-323 Ls = 1.3 nH Cpkg = 0.12 pF |
|-----------------|---|--|--|---|--------------------------------------|--|
| | | | | Each Diode Carrier Lifetime ⁴ (ms) | Each Diode I-Region Thickness (mils) | |
| MA4P275CK-1146T | 75 | 1.00 @ 20V | 0.5 | 0.2 | 0.4 |  |
| MA4P789CK-1146T | 75 | 0.35 @ 20V | 1.5 | 0.2 | 0.4 | |
| MA4P274CK-1146T | 100 | 0.35 @ 50V | 3.0 | 1.0 | 0.2 | |

SOT-323 Common Anode

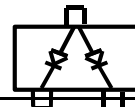
| Model Number | Reverse Voltage V_R ¹ (Volts) | Maximum Total Capacitance ² (pF) | Maximum R_s @ 10 mA ³ (Ohms) | Nominal Characteristics | | SOT-323 Ls = 1.3 nH Cpkg = 0.12 pF |
|-----------------|--|---|---|------------------------------------|---------------------------|---|
| | | | | Carrier Lifetime ⁴ (ms) | I-Region Thickness (mils) | |
| MA4P275CA-1146T | 75 | 1.00 @ 20V | 0.5 | 0.2 | 0.4 |  |
| MA4P789CA-1146T | 75 | 0.35 @ 20V | 1.5 | 0.2 | 0.4 | |
| MA4P274CA-1146T | 100 | 0.35 @ 50V | 3.0 | 1.0 | 2.0 | |

1. The reverse current will not exceed 10 μ A at the Reverse Voltage rating.
2. Maximum total capacitance is measured at 1 MHz at the indicated voltage.
3. Maximum series resistance is measured at the specified current and a frequency of 100 MHz.
4. Nominal minority lifetime is measured at $I_F = 10$ mA, $I_R = 6$ mA, 90% recovery.
5. Also available as reverse polarity series pairs. Designated as "MA4P275STR-1146", etc.

Specifications subject to change without notice.

- North America: Tel. (800) 366-2266
- Asia/Pacific: Tel.+81-44-844-8296, Fax +81-44-844-8298
- Europe: Tel. +44 (1344) 869 595, Fax+44 (1344) 300 020

Visit www.macom.com for additional data sheets and product information.

SOD-323

Electrical Specifications @ 25°C — SOD-323 Single Diode

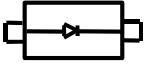
| Model Number | Reverse Voltage V_R ¹ (Volts) | Maximum Total Capacitance ² (pF) | Maximum R_S @ 10 mA ³ (Ohms) | Nominal Characteristics | | SOT-323 Ls = 1.2 nH Cpkg = 0.11 pF |
|---------------|--|---|---|------------------------------------|---------------------------|---|
| | | | | Carrier Lifetime ⁴ (ns) | I-Region Thickness (mils) | |
| MA4P275-1141T | 75 | 1.00 @ 20V | 0.5 | 0.2 | 0.4 |  |
| MA4P789-1141T | 75 | 0.35 @ 20V | 1.5 | 0.2 | 0.4 | |
| MA4P282-1141T | 100 | 1.20 @ 20V | 0.6 | 1.0 | 0.8 | |
| MA4P274-1141T | 100 | 0.35 @ 50V | 3.0 | 1.0 | 2.0 | |
| MA4P277-1141T | 200 | 0.35 @ 50V | 6.0 | 2.0 | 4.0 | |
| MA4P278-1141T | 200 | 0.35 @ 50V | 10.0 | 3.0 | 7.0 | |

1. The reverse current will not exceed 10 μ A at the Reverse Voltage rating.
2. Maximum total capacitance is measured at 1 MHz at the indicated voltage.
3. Maximum series resistance is measured at the specified current and a frequency of 100 MHz.
4. Nominal minority lifetime is measured at $I_F = 10$ mA, $I_R = 6$ mA, 90% recovery.

SOT-143

Electrical Specifications @ 25°C — SOT-143 Unconnected Pair

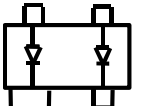
| Model Number | Reverse Voltage V_R ¹ (Volts) | Maximum Total Capacitance ² (pF) | Maximum R_S @ 10 mA ³ (Ohms) | Nominal Characteristics | | SOT-143 Ls = 1.2 nH Cpkg = 0.14 pF |
|---------------|--|---|---|------------------------------------|---------------------------|---|
| | | | | Carrier Lifetime ⁴ (ns) | I-Region Thickness (mils) | |
| MA4P275-1068T | 75 | 1.00 @ 20V | 0.5 | 0.2 | 0.4 |  |
| MA4P789-1068T | 75 | 0.35 @ 20V | 1.5 | 0.2 | 0.4 | |
| MA4P274-1068T | 100 | 0.35 @ 50V | 3.0 | 1.0 | 2.0 | |

1. The reverse current will not exceed 10 μ A at the Reverse Voltage rating.
2. Maximum total capacitance is measured at 1 MHz at the indicated voltage.
3. Maximum series resistance is measured at the specified current and a frequency of 100 MHz.
4. Nominal minority lifetime is measured at $I_F = 10$ mA, $I_R = 6$ mA, 90% recovery.

Specifications subject to change without notice.

- North America: Tel. (800) 366-2266
- Asia/Pacific: Tel.+81-44-844-8296, Fax +81-44-844-8298
- Europe: Tel. +44 (1344) 869 595, Fax+44 (1344) 300 020

Visit www.macom.com for additional data sheets and product information.

SC-79

Electrical Specifications @ 25°C — SC-79 Single Diode

| Model Number | Reverse Voltage V_R ¹ (Volts) | Maximum Total Capacitance ² (pF) | Maximum R_S @ 10 mA ³ (Ohms) | Nominal Characteristics | | SC-79 Ls = 0.6 nH Cpkg = 0.10 pF |
|---------------|--|---|---|------------------------------------|---------------------------|---|
| | | | | Carrier Lifetime ⁴ (ms) | I-Region Thickness (mils) | |
| MA4P275-1279T | 75 | 1.00 @ 20V | 0.5 | 0.2 | 0.4 |  |
| MA4P789-1279T | 75 | 0.35 @ 20V | 1.5 | 0.2 | 0.4 | |
| MA4P274-1279T | 100 | 0.35 @ 50V | 3.0 | 1.0 | 2.0 | |
| MA4P277-1279T | 200 | 0.35 @ 50V | 6.0 | 2.0 | 4.0 | |

1. The reverse current will not exceed 10 μ A at the Reverse Voltage rating.
2. Maximum total capacitance is measured at 1 MHz at the indicated voltage.
3. Maximum series resistance is measured at the specified current and a frequency of 100 MHz.
4. Nominal minority lifetime is measured at $I_F = 10$ mA, $I_R = 6$ mA, 90% recovery.

Specifications subject to change without notice.

- North America: Tel. (800) 366-2266
- Asia/Pacific: Tel.+81-44-844-8296, Fax +81-44-844-8298
- Europe: Tel. +44 (1344) 869 595, Fax+44 (1344) 300 020

Visit www.macom.com for additional data sheets and product information.

Typical Forward Resistance vs DC Bias Current Curves @ 100 MHz

Resistance vs Forward Current
(MA4P274 Series)

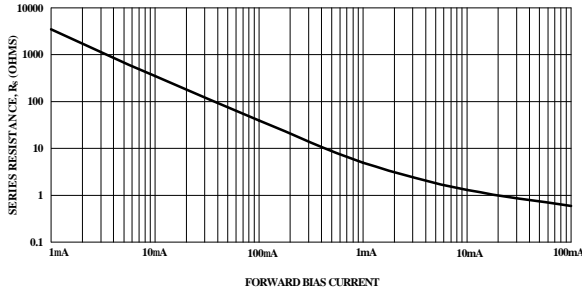

Resistance vs Forward Current
(MA4P275 Series)

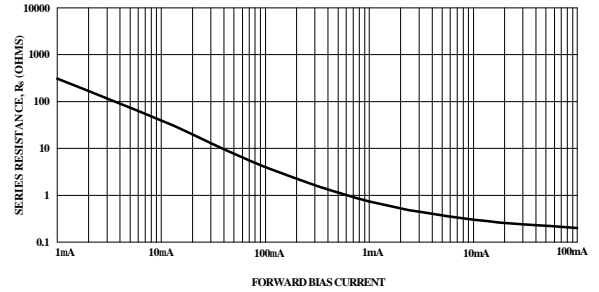

Resistance vs Forward Current
(MA4P277 Series)

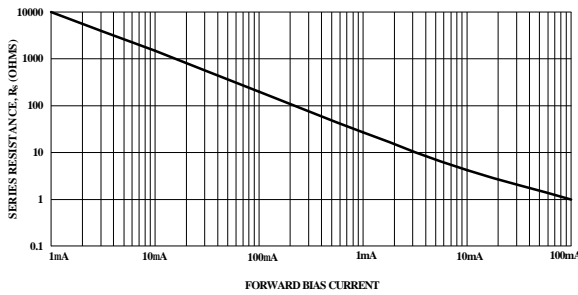

Resistance vs Forward Current
(MA4P278 Series)

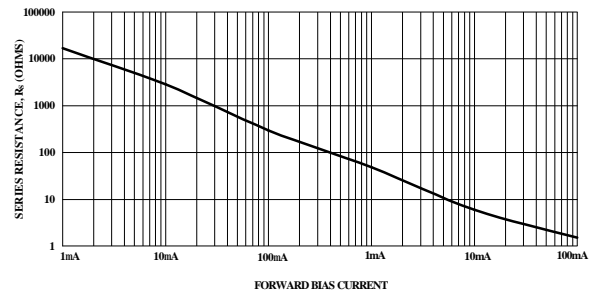

Resistance vs Forward Current
(MA4P282 Series)

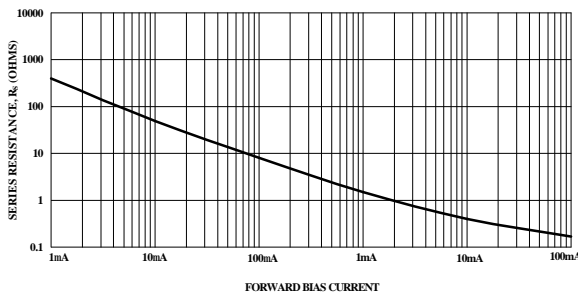

Resistance vs Forward Current
(MA4P789 Series)

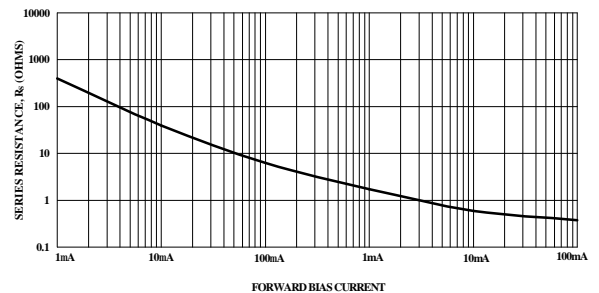

Specifications subject to change without notice.

- North America: Tel. (800) 366-2266
- Asia/Pacific: Tel.+81-44-844-8296, Fax +81-44-844-8298
- Europe: Tel. +44 (1344) 869 595, Fax+44 (1344) 300 020

Visit www.macom.com for additional data sheets and product information.

PIN Diode Cross Reference

Many of M/A-COM's glass axial lead hermetic surface mount and plastic PIN diodes use similar chips and, therefore, have the same electrical characteristics, except for package parasitics.

The following table lists the SOT-23, SOT-323 and SOD-323 PIN diodes by model number and standard axial lead PIN diode and the equivalent square surface mount (SMQ) PIN diodes.

| SOT-23 Diodes | Axial Lead Glass Diodes | SMQ Diodes |
|---------------|-------------------------|------------|
| MA4P274-287T | MA47123 | MA4PH236 |
| MA4P275-287T | MA4P270 | MA4PH235 |
| MA4P277-287T | MA47110 | MA4PH238 |
| MA4P278-287T | MA47100 | — |
| MA4P282-287T | MA4PH151 | — |
| MA4P789-287T | MA4PH401 | — |

| SOT-323 Diodes | Axial Lead Glass Diodes | SMQ Diodes |
|----------------|-------------------------|------------|
| MA4P274-1146T | MA47123 | MA4PH236 |
| MA4P275-1146T | MA4P270 | MA4PH235 |
| MA4P277-1146T | MA47110 | MA4PH238 |
| MA4P278-1146T | MA47100 | — |
| MA4P282-1146T | MA4PH151 | — |
| MA4P789-1146T | MA4PH401 | — |

| SOD-323 Diodes | Axial Lead Glass Diodes | SMQ Diodes |
|----------------|-------------------------|------------|
| MA4P274-1141T | MA47123 | MA4PH236 |
| MA4P275-1141T | MA4P270 | MA4PH235 |
| MA4P277-1141T | MA47110 | MA4PH238 |
| MA4P278-1141T | MA47100 | — |
| MA4P282-1141T | MA4PH151 | — |
| MA4P789-1141T | MA4PH401 | — |

Mounting Information

The illustration indicates the recommended mounting pad configuration for the SOT-23, SOT-323, SOD-323, SOT-143, and SC-79 packages. Solder paste containing flux should be screened onto the pads to a thickness of 0.005- 0.007 inches. The plastic package device is placed in position, firmly adhering to the solder paste.

Permanent attachment is performed by a reflow soldering procedure during which the tab temperature does not exceed +275°C and the body temperature does not exceed +250°C.

SOT-23

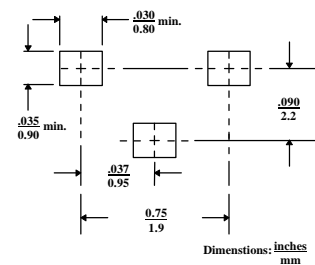

SOT-323

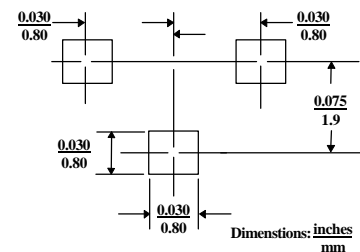

SOD-323

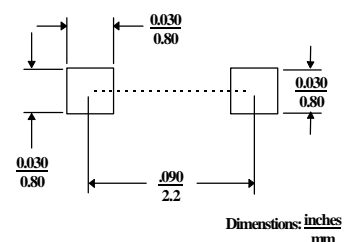

Specifications subject to change without notice.

- North America: Tel. (800) 366-2266
- Asia/Pacific: Tel. +81-44-844-8296, Fax +81-44-844-8298
- Europe: Tel. +44 (1344) 869 595, Fax +44 (1344) 300 020

Visit www.macom.com for additional data sheets and product information.

SOT-143

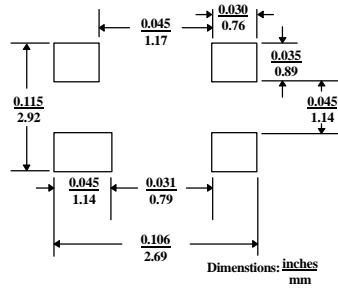

SC-79

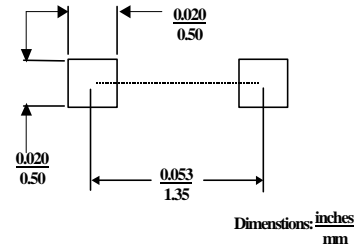

Case Styles

SOT-23
Case Style 287

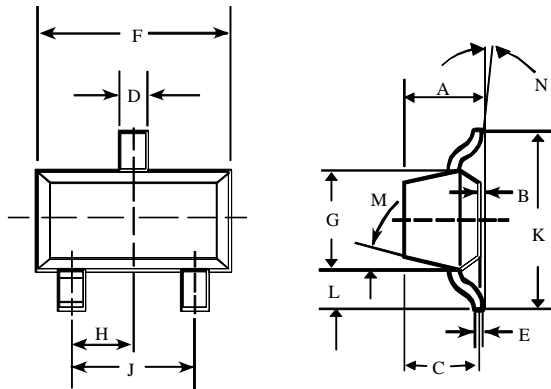

SOT-23 (Case Style 287)

| DIM. | INCHES | | MILLIMETERS | |
|-------------|-----------------------|-------|--------------|------|
| | MIN. | MAX. | MIN. | MAX. |
| A | — | 0.048 | — | 1.22 |
| B | — | 0.008 | — | 0.20 |
| C | — | 0.040 | — | 1.00 |
| D | 0.013 | 0.020 | 0.35 | 0.50 |
| E | 0.003 | 0.006 | 0.08 | 0.15 |
| F | 0.110 | 0.119 | 2.80 | 3.00 |
| G | 0.047 | 0.056 | 1.20 | 1.40 |
| H | 0.037 typical | | 0.95 typical | |
| J | 0.075 typical | | 1.90 typical | |
| K | — | 0.103 | — | 2.60 |
| L | — | 0.024 | — | 0.60 |
| DIM. | GRADIENT | | | |
| M | 10° max. ¹ | | | |
| N | 2° . . . 30° | | | |

Note: 1. Applicable on all sides

SOT-323
Case Style 1146

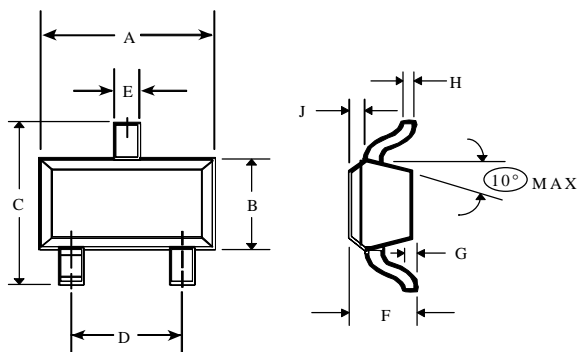

SOT-323 (Case Style 1146)

| DIM. | INCHES | | MILLIMETERS | |
|------|--------|-------|-------------|------|
| | MIN. | MAX. | MIN. | MAX. |
| A | 0.063 | 0.087 | 1.6 | 2.2 |
| B | 0.045 | 0.053 | 1.15 | 1.35 |
| C | 0.079 | 0.087 | 2.0 | 2.2 |
| D | 0.047 | 0.055 | 1.2 | 1.4 |
| E | 0.008 | 0.016 | 0.2 | 0.4 |
| F | 0.031 | 0.039 | 0.8 | 1.0 |
| G | — | 0.004 | — | 0.1 |
| H | 0.003 | 0.006 | 0.08 | 0.15 |
| J | 0.004 | 0.010 | 0.1 | 0.25 |

Specifications subject to change without notice.

- North America: Tel. (800) 366-2266
- Asia/Pacific: Tel.+81-44-844-8296, Fax +81-44-844-8298
- Europe: Tel. +44 (1344) 869 595, Fax+44 (1344) 300 020

Visit www.macom.com for additional data sheets and product information.

Case Styles (Cont'd)

SOD-323
Case Style 1141

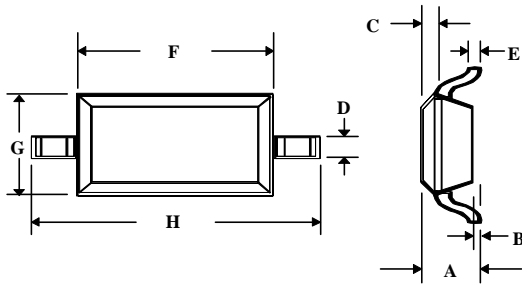

SOD-323 (Case Style 1141)

| DIM. | INCHES | | MILLIMETERS | |
|------|--------|-------|-------------|------|
| | MIN. | MAX. | MIN. | MAX. |
| A | — | 0.043 | — | 1.1 |
| B | — | 0.004 | — | 0.1 |
| C | — | 0.008 | — | 0.2 |
| D | 0.010 | 0.016 | 0.25 | 0.4 |
| E | 0.003 | 0.006 | 0.08 | 0.15 |
| F | 0.063 | 0.075 | 1.6 | 1.9 |
| G | 0.045 | 0.057 | 1.15 | 1.45 |
| H | 0.091 | 0.106 | 2.3 | 2.7 |

SOT-143
Case Style 1068

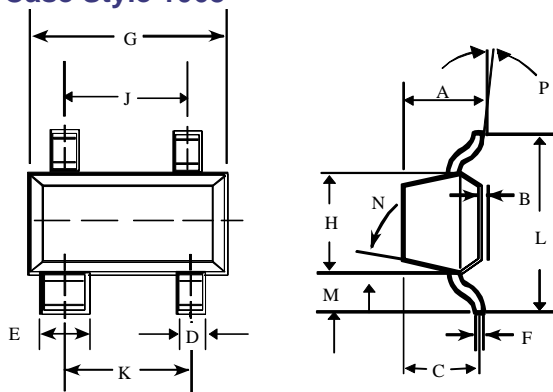

SOT-143 (Case Style 1068)

| DIM. | INCHES | | MILLIMETERS | |
|-------------|-----------------------|-------|--------------|------|
| | MIN. | MAX. | MIN. | MAX. |
| A | — | 0.044 | — | 1.10 |
| B | — | 0.004 | — | 0.10 |
| C | — | 0.040 | — | 1.00 |
| D | 0.013 | 0.020 | 0.35 | 0.50 |
| E | 0.030 | 0.035 | 0.75 | 0.90 |
| F | 0.003 | 0.006 | 0.08 | 0.15 |
| G | 0.110 | 0.119 | 2.80 | 3.00 |
| H | 0.047 | 0.056 | 1.20 | 1.40 |
| J | 0.075 typical | | 1.90 typical | |
| K | 0.075 typical | | 1.90 typical | |
| L | — | 0.103 | — | 2.6 |
| M | — | 0.024 | — | 0.6 |
| DIM. | GRADIENT | | | |
| M | 10° max. ¹ | | | |
| N | 2° . . . 30° | | | |

Note: 1. Applicable on all sides

Specifications subject to change without notice.

- North America: Tel. (800) 366-2266
- Asia/Pacific: Tel.+81-44-844-8296, Fax +81-44-844-8298
- Europe: Tel. +44 (1344) 869 595, Fax+44 (1344) 300 020

Visit www.macom.com for additional data sheets and product information.

Case Styles (Cont'd)

SC-79
Case Style ODS-1279

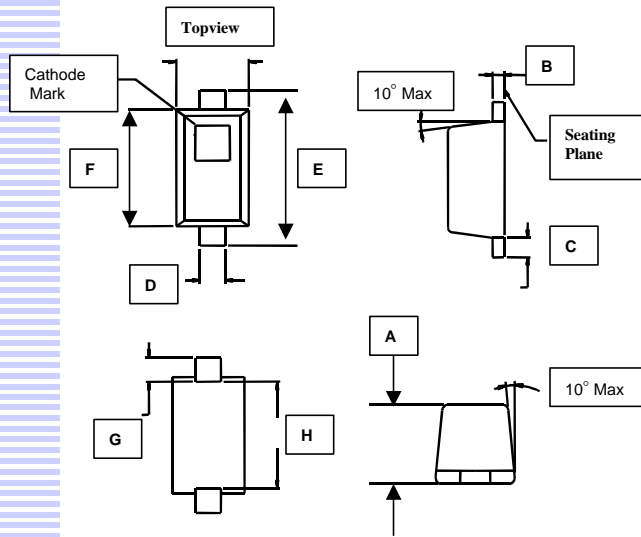

SC-79 (Case Style 1279)

| DIM. | INCHES | | MILLIMETERS | |
|------|--------|-------|-------------|------|
| | MIN. | MAX. | MIN. | MAX. |
| A | 0.020 | 0.028 | 0.50 | 0.71 |
| B | 0.003 | 0.008 | 0.08 | 0.20 |
| C | 0.006 | 0.010 | 0.15 | 0.25 |
| D | 0.010 | 0.014 | 0.25 | 0.36 |
| E | 0.059 | 0.067 | 0.08 | 0.15 |
| F | 0.043 | 0.051 | 1.50 | 1.30 |
| G | 0.011 | 0.012 | 0.28 | 0.30 |
| H | 0.037 | 0.043 | 0.94 | 1.09 |

Specifications subject to change without notice.

- North America: Tel. (800) 366-2266
- Asia/Pacific: Tel.+81-44-844-8296, Fax +81-44-844-8298
- Europe: Tel. +44 (1344) 869 595, Fax+44 (1344) 300 020

Visit www.macom.com for additional data sheets and product information.